

Un mondo di porte

A world of doors

Un monde de portes

CATALOGO GENERALE
GENERAL CATALOGUE
CATALOGUE GÉNÉRAL

2025

Innovativi per tradizione

1975



La tradizione artigianale toscana incontra l'esperienza della famiglia Fedi. Nasce OTC snc, azienda specializzata nella commercializzazione e distribuzione di porte interne, infissi e serramenti per il mercato nazionale.

The Tuscan craftsmanship tradition meets the Fedi family's experience. OTC Snc was established, a Company specializing in the distribution of internal doors and windows for the national market.

La tradition artisanale toscane s'unit à l'expérience de la famille Fedi. Voici OTC snc, une société spécialisée dans la commercialisation et la distribution de portes internes, d'huissieries et de châssis sur le marché Italien.

2005



OTC DOORS costruisce a Serravalle Pistoiese un nuovo impianto produttivo con una superficie di oltre 4.000 mq e tecnologia di ultima generazione per incrementare le performance e gli standard qualitativi dei propri prodotti.

OTC DOORS constructed a new manufacturing plant in Serravalle Pistoiese, which covers an area of 4000 square meters, with next-generation technology to raise the performance and quality of its products.

La nouvelle usine de OTC DOORS, distribuée sur plus de 4.000 m2 de surface, se situe à Serravalle Pistoiese; on l'a équipée de technologie de toute dernière génération afin d'améliorer les performances et les standards de ses propres produits en termes de qualité.



2000

OTC Snc diventa OTC DOORS Srl. Si ampliano gli stabilimenti e le strutture commerciali per rispondere in modo efficace alle esigenze di mercati sempre più ampi e internazionali.

OTC snc turns into OTC DOORS Srl. New sites and new sales facilities are opened to effectively meet the need of increasingly large and international markets.

OTC Snc est devenu OTC DOORS Srl. Les établissements et les structures commerciales se sont agrandies pour mieux répondre à des exigences de marché de plus en plus vastes et globales.



2014

Nasce ITP Srl, acronimo di Industria Toscana Porte, che produce e distribuisce i prodotti a marchio OTC DOORS. La nuova Società segna il passaggio generazionale alla direzione dell'azienda dal fondatore ai figli e ai nuovi soci, che ricoprono e seguono direttamente le principali funzioni del processo progettuale, produttivo, commerciale e finanziario.

ITP Srl was established as an acronym for Industria Toscana Porte, which manufactures and distributes OTC DOORS brand products. The new Company marks a generational shift from the founder to his sons and new partners, who hold and directly follow the main features of the design, production, trade and financial processes.

Nous vous présentons ITP Srl, acronyme de Industria Toscana Porte, laquelle produit et distribue les produits de la marque OTC DOORS. Cette nouvelle Société marque le passage générationnel du fondateur qui confie la direction à ses enfants et aux nouveaux associés, lesquels occupent les principales fonctions liées à la conception, la production, aux aspects commercial et financier, qu'ils suivent directement.

Made in Toscana, Italia

Made in Tuscany, Italy Made in Toscana, Italie

Lo stabilimento produttivo di Serravalle Pistoiese, che si estende su una superficie di 4000 mq, è il quartier generale dove prendono forma le creazioni firmate OTC DOORS.

Questo impianto accoglie un innovativo sistema di lavorazione a isole con macchinari automatizzati ad alta precisione capaci di realizzare con la stessa efficienza sia produzioni in serie che commesse personalizzate anche in piccoli quantitativi. Dalla progettazione all'assemblaggio, dal controllo qualità alla spedizione in tutto il mondo: ogni fase del processo produttivo è seguita direttamente dalla proprietà avvalendosi di personale altamente specializzato, a garanzia di prodotti che sono il frutto di un perfetto mix tra tecnologia e tradizione, degni interpreti dell'eccellenza Made in Italy.

Lo stabilimento accoglie inoltre un ampio showroom interno dove agenti, rivenditori, progettisti e i loro clienti finali possono toccare con mano la qualità dei prodotti e valutare in anteprima le ultime novità OTC DOORS.

OTC DOORS constructed a new manufacturing plant in Serravalle Pistoiese, which covers an area of 4000 square meters, where OTC DOORS brand products are created.

This plant accommodates an innovative multi-level processing system with high precision automated machinery to achieve the same mass production efficiency and custom orders even in small quantities.

From design to assembly, from quality control to shipping all over the world: each stage of the production process is followed directly by the estate with highly specialized personnel, to guarantee products which blend technology and tradition, representing the excellence Made in Italy.

The plant also includes a large internal showroom where agents, retailers, designers and their end customers can have a hands-on experience of the products' quality and assess the first preview of the latest OTC DOORS products.

L'usine de Serravalle Pistoiese, de plus de 4000 m2 de surface constitue le quartier général ; c'est là que les créations signées OTC DOORS prennent vie.

Ce site accueille un système d'usinage à îlots tout à fait novateur ainsi que des machines automatisées, de très grande précision, capables de traiter tout aussi bien les productions en série que les commandes personnalisées, en plus petites quantités, avec le même soin.

De la conception à l'assemblage, du contrôle qualité aux livraisons, partout dans le monde: chaque phase du processus de production est suivie directement par les propriétaires qui peuvent vanter un personnel hautement spécialisé, à garantie de produits qui sont le fruit d'un parfait mélange entre technologie et tradition, dignes interprètes de l'excellence Made in Italy.

L'établissement accueille également un vaste showroom interne où les agents, les revendeurs, les concepteurs et leurs clients de destination pourront juger personnellement de la qualité des produits et, en avant-première, évaluer les toutes dernières nouveautés de la Société OTC DOORS.



OTC DOORS per l'ambiente

OTC DOORS for the environment OTC DOORS et l'environnement

La sostenibilità ambientale e il rispetto della salute umana sono valori fondamentali per OTC DOORS che si impegna attivamente attraverso scelte consapevoli nel proprio impianto produttivo, come l'impiego di energia da fonti rinnovabili con una riduzione sostanziale delle emissioni di CO2. L'impianto fotovoltaico installato presso il nostro stabilimento è in grado di soddisfare il fabbisogno energetico annuo dell'azienda e di oltre 50 famiglie.

Environmental sustainability and safeguarding human health are fundamental values for OTC DOORS which is consciously involved in its own production facility, such as the use of energy from renewable sources with a substantial reduction in CO2 emissions. The photovoltaic system installed at our factory can meet the annual energy requirements of the company and over 50 families.

La durabilité environnementale et le respect pour la santé humaine sont des valeurs fondamentales pour notre Société laquelle, au sein de sa propre usine, s'est engagée à travers des choix conscients tels que, par exemple, l'emploi d'énergies renouvelables et donc une réduction considérable des émissions de CO2. L'équipement photovoltaïque installé permet de satisfaire les besoins annuels de l'entreprise en énergie mais de 50 autres familles également.



Un mondo di porte

A world of doors Un monde de portes

Qualunque sia il tuo stile, OTC DOORS veste la casa con prodotti duraturi e di qualità, pensati anche per progetti residenziali e pubblici. La continua ricerca nella creazione di collezioni dalle alte prestazioni estetiche e funzionali, consente ad OTC DOORS di offrire un'ampia gamma di soluzioni in grado di assecondare qualsiasi esigenza: l'eleganza contemporanea di VENTIVENTI, le vibranti superfici di DUAL, il sapore rustico della collezione GRANDUCATO, il design pulito e intramontabile di OTELLO, il gusto sofisticato dei laccati di BUTTERFLY, TURANDOT e TOSCA, la sicurezza e la versatilità dei portoni blindati OTC DOORS SECURITY e la tecnologia del progetto ZEUS per porte antincendio.

Un mondo di porte per chi ama arredare con l'inconfondibile gusto del Made in Italy.

Whatever your style, OTC DOORS dresses the house with durable and quality products, also designed for residential and public projects.

The continuous research in the creation of collections with high aesthetic and functional performances, allows OTC DOORS to offer a wide range of solutions able to satisfy any requirement: the contemporary elegance of VENTIVENTI, the vibrant DUAL surfaces, the rustic touch of the GRAND DUCHY collection, the neat and timeless of OTELLO design, the sophisticated taste of the BUTTERFLY, TURANDOT and TOSCA varnish, the safety and versatility of the OTC DOORS SECURITY armoured doors and the ZEUS technology for fire-proof doors. A world of doors for those who love decoration with the unmistakable Made in Italy style.

Quel que soit votre style, OTC DOORS habille la maison de produits durables et de qualité, également conçus pour les projets résidentiels et publics.

La recherche continue dans la création de collections aux hautes performances esthétiques et fonctionnelles, permet à OTC DOORS de proposer une large gamme de solutions capables de satisfaire tout besoin: l'élégance contemporaine de VENTIVENTI, les surfaces vibrantes de DUAL, la saveur rustique de la collection GRANDUCATO, le design propre et atemporel de OTELLO, le goût sophistiqué des laqués de BUTTERFLY, TURANDOT et TOSCA, la sécurité et la versatilité des portes blindées OTC DOORS SECURITY et la technologie du projet ZEUS pour portes coupe-feu. Un monde de portes pour les amateurs de la décoration au charme unique, Made in Italy.

OTC DOORS[®]
INDUSTRIA TOSCANA PORTE

Indice

Porte
Doors
Portes



pag. 8 VENTIVENTI



pag. 42 SEGNO



pag. 56 STILE



pag. 68 DUAL



pag. 118 TOSCA



pag. 132 BUTTERFLY



pag. 152 TURANDOT



pag. 170 OTELLO



pag. 184 GRANDUCATO

Porte speciali
e accessori
Special doors
and accessories
Portes spéciales
et accessoires



pag. 196 IMBOTTI



pag. 198 PORTE SPECIALI



pag. 204 MANIGLIE E BATTISCOPIA

Porte in vetro
Glass doors
Portes en verre



pag. 210 RIFLESSI - TUTTOVETRO

Finiture
Finishes
Finitions



pag. 258 FINITURE

Contract



pag. 272 DESIGN FOR CONTRACT

EE

VENTIVENTI



Eleganza contemporanea

Eleganza contemporanea

GESSO, LATTE, CALCE, PIUMA, SANDALO, CORDA: 6 finiture ricercate ed esclusive, ispirate ad un sofisticato minimalismo orientale, vestono le porte della nuova collezione di OTC DOORS.

Dall'ineccepibile funzionalità, la collezione VENTIVENTI è disponibile nelle versioni con cerniera anuba **WA** e cerniera a bilico registrabile a scomparsa **WB**, due alternative in grado di assecondare e valorizzare gli ambienti con gusto ed eleganza contemporanea.

Contemporary elegance

GESSO, LATTE, CALCE, PIUMA, SANDALO, CORDA: 6 refined and exclusive finishes, inspired by a sophisticated oriental minimalism, dress the doors of the new OTC DOORS collection.

With impeccable functionality, the VENTIVENTI collection is available in the versions with anuba hinge **WA** and concealed pivot hinge **WB**, two alternatives that can satisfy and enhance environments with contemporary taste and elegance.

Élégance contemporaine

GESSO, LATTE, CALCE, PIUMA, SANDALO, CORDA: 6 finitions raffinées et exclusives, inspirées d'un minimalisme oriental sophistiqué, habillent les portes de la nouvelle collection OTC DOORS.

Avec une fonctionnalité irréprochable, la collection VENTIVENTI est disponible dans les versions avec charnière anuba **WA** et charnière pivotante cachée **WB**, deux alternatives qui peuvent satisfaire et améliorer les environnements avec un goût et une élégance contemporains.

Interni Coordinati

Armonia ed eleganza sono alla base del concetto proposto da OTC DOORS per coordinare la porta blindata con il resto delle porte interne, grazie alla possibilità di avere il pannello interno, porte tuttovetro, coprifili e battiscopa delle stesse finiture della collezione VENTIVENTI.

Harmony and elegance are the basis of the concept proposed by OTC DOORS to coordinate the security door with the rest of the internal doors, thanks to the possibility of having the internal panel, all glass doors, backlining and skirting of the same finishes as the VENTIVENTI collection.

L'harmonie et l'élégance sont à la base du concept proposé par OTC DOORS pour coordonner la porte blindée avec le reste des portes intérieures, grâce à la possibilité d'avoir le panneau intérieur, portes tout en verre, cache-fils et plinthe des mêmes finitions que la collection VENTIVENTI.



WA4 - WB4

Finitura GESSO , vetro Foglie Verdi
GESSO finishing, foglie Verdi glass
Finition GESSO, verre Foglie Verdi

WA3 - WB3

Finitura GESSO
GESSO finishing
Finition GESSO

PORTA BLINDATA NEREA
SECURITY DOOR NEREA
PORTE DE SÉCURITÉ NEREA

Rivestimento interno WA3 - WB3 GESSO
Internal panel WA3 - WB3 GESSO
Panneaux intérieur WA3 - WB3 GESSO



WA1 - WB1

Finitura LATTE
LATTE finishing
Finition LATTE

TUTTOVETRO

Porta a battente, finitura LATTE, vetro fumé trasparente
Hinged door, LATTE finishing, transparent smoked glass
Porte battante, finition LATTE, verre fumé transparent

TUTTOVETRO

Scorrevole a scomparsa, finitura LATTE; vetro fumé trasparente
Fully-retracting sliding door, LATTE finishing, transparent smoked glass
Porte coulissante escamotable, finition LATTE, verre fumé transparentes

Interni Coordinati

Armonia ed eleganza sono alla base del concetto proposto da OTC DOORS per coordinare la porta blindata con il resto delle porte interne, grazie alla possibilità di avere il pannello interno, porte tuttovetro, coprifili e battiscopa delle stesse finiture della collezione VENTIVENTI.

Harmony and elegance are the basis of the concept proposed by OTC DOORS to coordinate the security door with the rest of the internal doors, thanks to the possibility of having the internal panel, all glass doors, backlining and skirting of the same finishes as the VENTIVENTI collection.

L'harmonie et l'élégance sont à la base du concept proposé par OTC DOORS pour coordonner la porte blindée avec le reste des portes intérieures, grâce à la possibilité d'avoir le panneau intérieur, portes tout en verre, cache-fils et plinthe des mêmes finitions que la collection VENTIVENTI.

PORTA BLINDATA NEREA
SECURITY DOOR NEREA
PORTE DE SÉCURITÉ NEREA

Rivestimento interno WA3 - WB3 PIUMA
Internal panel WA3 - WB3 PIUMA
Panneaux intérieurs WA3 - WB3 PIUMA

WA3 - WB3

Filo imbottito, finitura PIUMA
Blockboard coplanair, PIUMA finishing
Bâti coplanaires, finition PIUMA

WA3 - WB3

Filo imbottito, finitura PIUMA
Blockboard coplanair, PIUMA finishing
Bâti coplanaires, finition PIUMA

Interni Coordinati

Armonia ed eleganza sono alla base del concetto proposto da OTC DOORS per coordinare la porta blindata con il resto delle porte interne, grazie alla possibilità di avere il pannello interno, porte tuttovetro, coprifili e battiscopa delle stesse finiture della collezione VENTIVENTI.

Harmony and elegance are the basis of the concept proposed by OTC DOORS to coordinate the security door with the rest of the internal doors, thanks to the possibility of having the internal panel, all glass doors, backlining and skirting of the same finishes as the VENTIVENTI collection.

L'harmonie et l'élégance sont à la base du concept proposé par OTC DOORS pour coordonner la porte blindée avec le reste des portes intérieures, grâce à la possibilité d'avoir le panneau intérieur, portes tout en verre, cache-fils et plinthe des mêmes finitions que la collection VENTIVENTI.



WA3 - WB3

Finitura SANDALO
SANDALO finishing
Finition SANDALO

TUTTOVETRO

Porta a battente, finitura SANDALO, vetro Nest
Hinged door, SANDALO finishing, Nest glass
Porte battante, finition SANDALO, verre Nest

PORTA BLINDATA ELIDE
SECURITY DOOR ELIDE
PORTE DE SÉCURITÉ ELIDE

Rivestimento interno WA3 - WB3 SANDALO
Internal panel WA3 - WB3 SANDALO
Panneaux intérieur WA3 - WB3 SANDALO



PORTA BLINDATA NEREA
SECURITY DOOR NEREA
PORTE DE SÉCURITÉ NEREA

Rivestimento interno WA3 - WB3 CALCE
Internal panel WA3 - WB3 CALCE
Panneaux intérieur WA3 - WB3 CALCE

WA3 - WB3

Filo muro, Finitura CALCE
Flush wall, CALCE finishing
Invisible, finition CALCE

WA3 - WB3

Filo muro, Finitura CALCE
Flush wall, CALCE finishing
Invisible, finition CALCE



WB3 Finitura CALCE
CALCE finishing
Finition CALCE



PORTA BLINDATA NEREA
SECURITY DOOR NEREA
PORTE DE SÉCURITÉ NEREA

Rivestimento interno WA3 - WB3 GESSO
Internal panel WA3 - WB3 GESSO
Panneaux intérieur WA3 - WB3 GESSO



WA3 - WB3

Finitura CORDA
CORDA finishing
Finition CORDA

WA3 - WB3

1/3 2/3, Finitura CORDA
1/3 2/3, CORDA finishing
1/3 2/3, finition CORDA



WA3 - WB3 Scorrevole a scomparsa, finitura GESSO
Fully-retracting sliding door, GESSO finishing
Porte coulissante escamotable, finition GESSO



TUTTOVETRO Porta a battente, finitura CALCE, vetro Denim
Hinged door, CALCE finishing, Denim glass
Porte battante, finition CALCE, verre Denim



WA3 - WB3

Libro, Finitura SANDALO
Folding, SANDALO finishing
Pianta, Finiton SANDALO



WA3 - WB3

Scorrevole esterno parete con profilo di battuta, finitura CALCE
Exposed sliding door with stop upright, CALCE finishing
Coulissante externe paroi avec profil de rebord, finition CALCE



WB3 Scorrevole esterno, guida Invisibile EVO, finitura CALCE
 Exposed sliding door, sliding rail Invisibile EVO, CALCE finishing
 Porte coulissante externe paroi, rail de guidage Invisibile EVO, finition CALCE

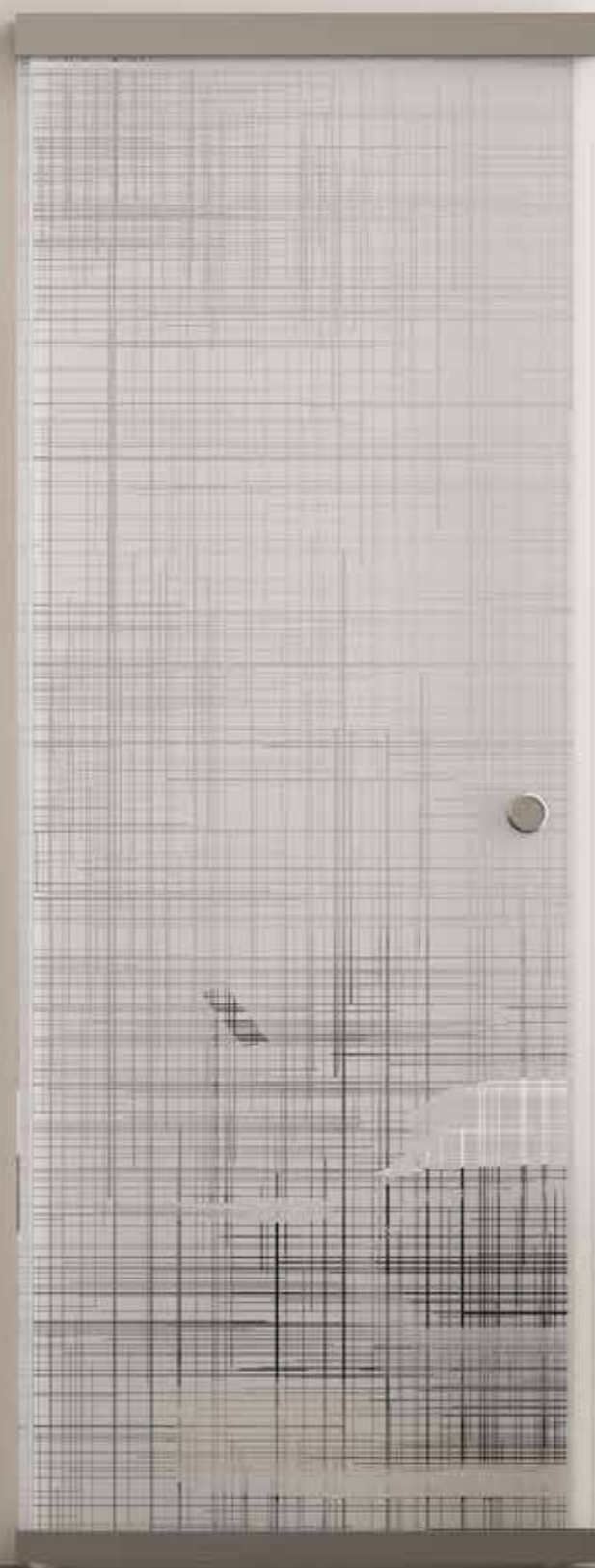

TUTTOVETRO Scorrevole esterno, Vetro Mondrian, guida Invisibile EVO
 Exposed sliding door, Mondrian glass, sliding rail Invisibile EVO
 Porte coulissante externe paroi, Verre Mondrian, rail de guidage Invisibile EVO



Disponibile sia per le porte tuttovetro che per quelle in legno, il sistema scorrevole Invisibile EVO si distingue per l'assenza di qualsiasi tipo di meccanismo a vista, anche quando la porta è aperta. La porta, come rappresentato nelle immagini, occupa, aperta, 15 cm del vano passaggio. Per lasciare libera tutta la luce del vano andrà utilizzata una porta più larga di 22 cm del vano stesso e collocata in posizione decentrata.

Available for both all-glass and wooden doors, the Invisibile EVO sliding system stands out for the absence of any type of visible mechanism, even when the door is open. The door, as shown in the images, occupies 15 cm of the passageway when open. To leave all the space light free, a door wider than 22 cm must be used and placed in a decentralized position.

Disponible pour les portes tout verre et en bois, le système coulissant Invisibile EVO se distingue par l'absence de tout type de mécanisme visible, même lorsque la porte est ouverte. La porte, comme le montrent les images, occupe 15 cm du passage lorsqu'elle est ouverte. Pour laisser tout l'espace libre de lumière, une porte de plus de 22 cm doit être utilisée et placée en position décentralisée.





WA3 - WB3 Finitura CALCE
CALCE finishing
Finition CALCE



WB3 Finitura CORDA (Vista interna)
CORDA finishing (Internal view)
Finition CORDA (Vue intérieure)

EE

VENTIVENTI
CLASSIC



Classica eleganza

Classica eleganza

La quintessenza dello stile classico si svela in VENTIVENTI CLASSIC: la qualità del pannello laccato bianco e dell'imbotte coordinato in legno listellare laminato definiscono una porta senza tempo in grado di valorizzare ogni tipo di ambiente.

Classic elegance

The quintessence of the classic style is revealed in VENTIVENTI CLASSIC: the quality of the white lacquered panel and coordinated laminated wood padding define a timeless door capable of enhancing any type of environment.

Élégance classique

La quintessence du style classique se révèle dans VENTIVENTI CLASSIC: la qualité du panneau laqué blanc et le rembourrage en bois stratifié coordonné définissent une porte intemporelle capable d'améliorer tout type d'environnement.



TUTTOVETRO

Porta a battente, finitura BIANCO, vetro Mondrian
Hinged door, BIANCO finishing Mondrian glass
Porte battante, finition BIANCO, verre Mondrian

WL1

Finitura BIANCO
BIANCO finishing
Finition BIANCO

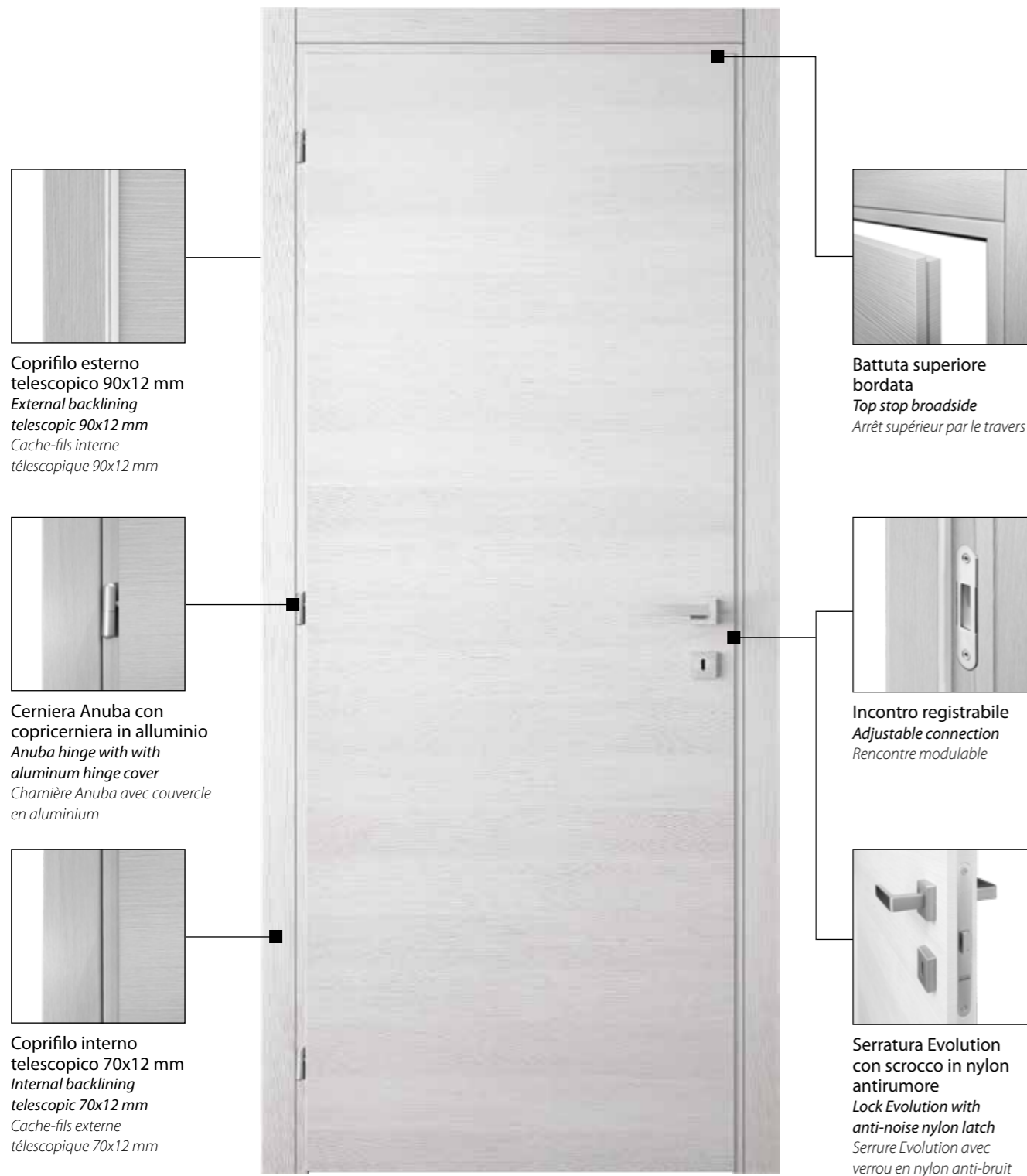

VENTIVENTI ANUBA



Battuta superiore bordata, anuba con copricerniera in alluminio, coprifilo esterno telescopico da 90 mm, serratura Evolution con scrocco in nylon antirumore. VENTIVENTI ANUBA amplia il concetto di porta con dettagli che ne aumentano le prestazioni estetiche e funzionali. Apertura fino a 180°.

Edged top stop, anuba with aluminum hinge cover, 90 mm external backlining telescopic, Evolution lock with anti-noise nylon latch. VENTIVENTI ANUBA expands the concept of door with details that increase its aesthetic and functional performance. Maximum opening 180°.

Arrêt supérieur par le travers, anuba avec couvercle de charnière en aluminium, couvercle extérieur télescopique de 90 mm, verrou Evolution avec verrou en nylon anti-bruit. VENTIVENTI ANUBA élargit le concept de porte avec des détails qui augmentent ses performances esthétiques et fonctionnelles. Ouverture maximale 180°.

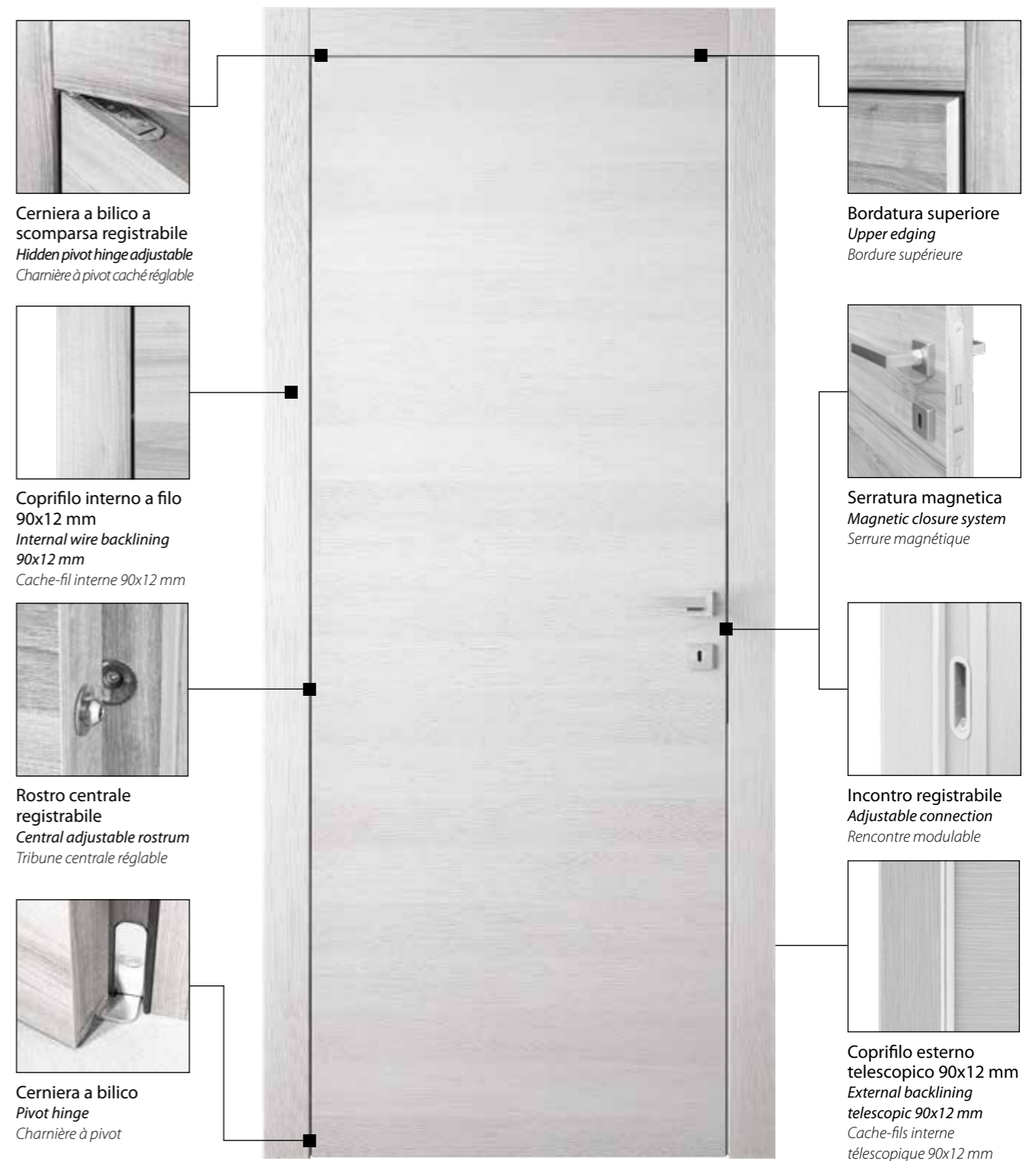

VENTIVENTI BILICO

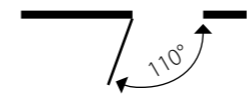

Cerniera a bilico a scomparsa, coprifilo interno a filo da 90 mm, serratura magnetica: dettagli preziosi che caratterizzano la porta VENTIVENTI BILICO, pensata per chi cerca uno stile minimale e raffinato. Apertura massima 110°.

Hidden pivot hinge, 90 mm Internal wire backlining, Magnetic closure system: precious details that characterize the VENTIVENTI BILICO door, designed for those looking for a minimal and refined style. Maximum opening 110°.

Charnière à pivot caché, Cache-fil interne de 90 mm, serrure magnétique: détails précieux qui caractérisent la porte VENTIVENTI BILICO, conçus pour ceux qui recherchent un style minimaliste et raffiné. Ouverture maximale 110°.



VENTIVENTI
CLASSIC



Pannello laccato con battuta su tre lati, coprifilo esterno telescopico da 90 mm, anuba con copricerniera in alluminio, serratura Evolution con scrocco in nylon antirumore: qualità e funzionalità per la porta VENTIVENTI CLASSIC, un prodotto in grado di valorizzare ogni tipo di ambiente con gusto ed eleganza. Apertura fino a 180°.

Lacquered panel with ledge on three sides, 90 mm external backlining telescopic, anuba with aluminum hinge cover, Evolution lock with anti-noise nylon latch: quality and functionality for the VENTIVENTI CLASSIC door, a product capable of enhancing any type of environment with taste and elegance. Maximum opening 180°.

Lacquered panel with batting on three sides, couvercle extérieur télescopique de 90 mm, anuba avec couvercle de charnière en aluminium, verrou Evolution avec verrou en nylon anti-bruit: qualité et fonctionnalité pour la porte VENTIVENTI CLASSIC, un produit capable de mettre en valeur tout type d'environnement avec goût et élégance. Ouverture maximale 110°.

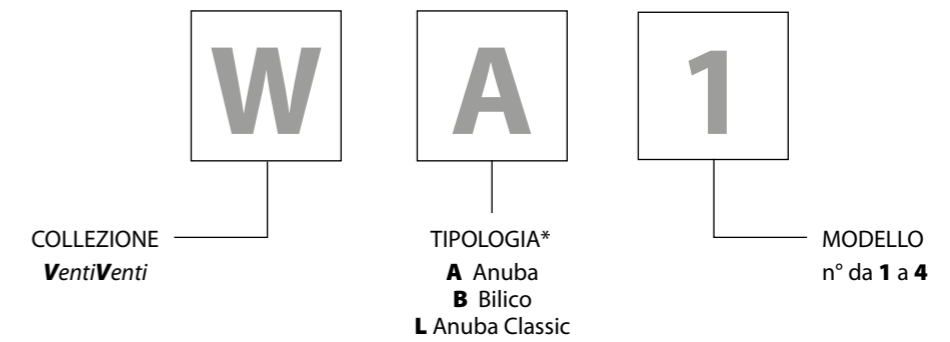

Anuba

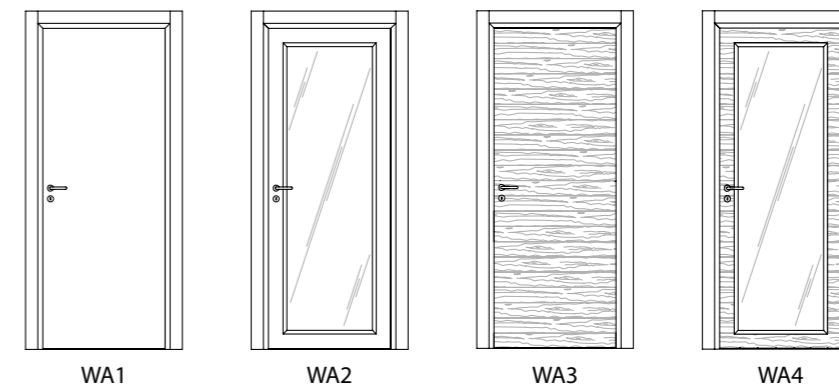

Bilico



Classic

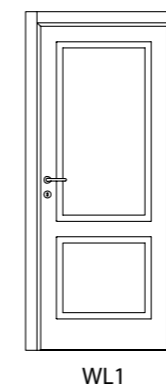

*Le porte speciali (rototraslante, libro, 1/3 2/3, filo imbotte, scorrevole, TUTTOVETRO, ecc) avranno un proprio sistema di apertura specifico. Special doors (rototraslating, folding, 1/3 2/3, blockboard coplanair, sliding door, TUTTOVETRO, ecc) will have their own specific opening system. Les portes spéciales (pivotante, pliante, 1/3 2/3, bâti coplanaires, porte coulissante paroi) auront leur propre système d'ouverture spécifique.

WA VENTIVENTI ANUBA WL VENTIVENTI CLASSIC

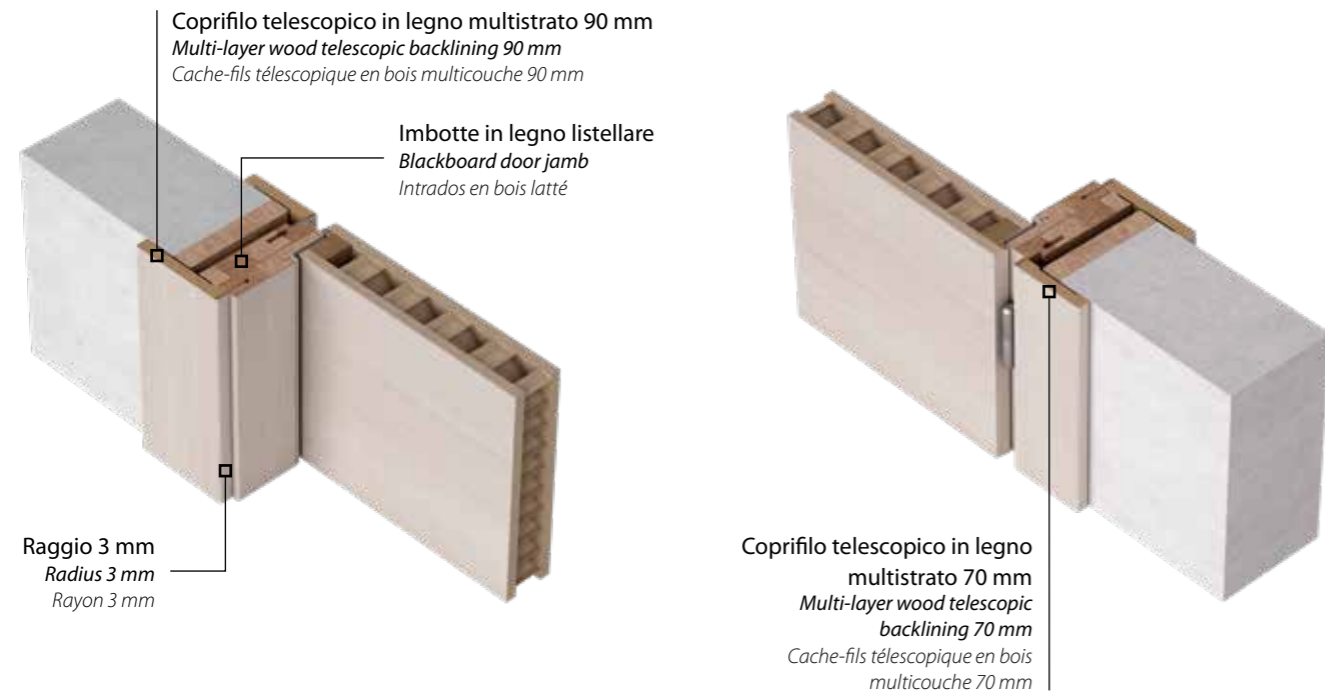

WB VENTIVENTI BILICO

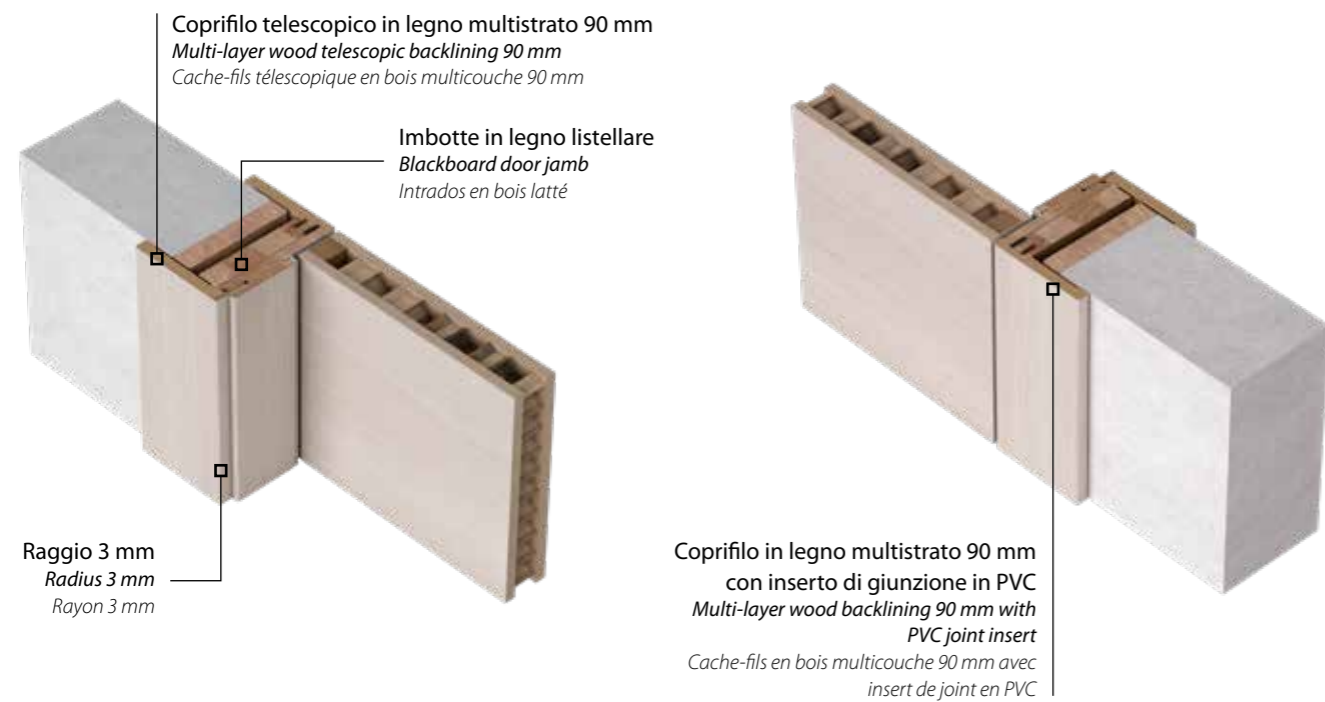

CALCE



PIUMA



CORDA



LATTE



GESSO



SANDALO



Leggiadra eleganza

Leggiadra eleganza

Un gesto gentile ma deciso che esalta le preziose superfici laccate: una delicata incisione che si distingue per le eleganti estremità rese appuntite dalla particolare tecnica di lavorazione computerizzata rifinita a mano. L'affidabilità della serie di porte tamburate laccate con imbotte in listellare di OTC DOORS si arricchisce di una nuova collezione pensata per valorizzare gli ambienti con un tocco di rinnovata originalità.

Graceful elegance

A gentle but decisive gesture that enhances the precious lacquered surfaces: a delicate incision that stands out for the elegant ends made pointed by the particular hand-finished computerized processing technique. The reliability of the OTC DOORS series of lacquered honeycomb doors with blockboard intrados is enriched with a new collection designed to enhance environments with a touch of renewed originality.

Élégance gracieuse

Un geste doux mais décisif qui met en valeur les précieuses surfaces laquées : une incision délicate qui se distingue par les extrémités élégantes rendues pointues par la technique de traitement informatisée particulière finie à la main. La fiabilité de la série OTC DOORS de portes alvéolées laquées avec intrados en latté s'enrichit d'une nouvelle collection conçue pour mettre en valeur les environnements avec une touche d'originalité renouvelée.

301 Laccato RAL 9003, imbotte Raggio 2
Lacquered RAL 9003, Radius 2 blockboard
Laqué RAL 9003, bâti Rayon 2



303 Laccato RAL 7024, imbotte Raggio 2
Lacquered RAL 7024, Radius 2 blockboard
Laqué RAL 7024, bâti Rayon 2



305 Laccato RAL 9003, imbotte Raggio 2
Lacquered RAL 9003, Radius 2 blockboard
Laqué RAL 9003, bâti Rayon 2



307 | Laccato RAL 7036, imbotte Raggio 2
Lacquered RAL 7036, Radius 2 blockboard
Laqué RAL 7036, bâti Rayon 2



310 Laccato RAL 1013, imbotte Raggio 2
Lacquered RAL 1013, Radius 2 blockboard
Laqué RAL 1013, bâti Rayon 2



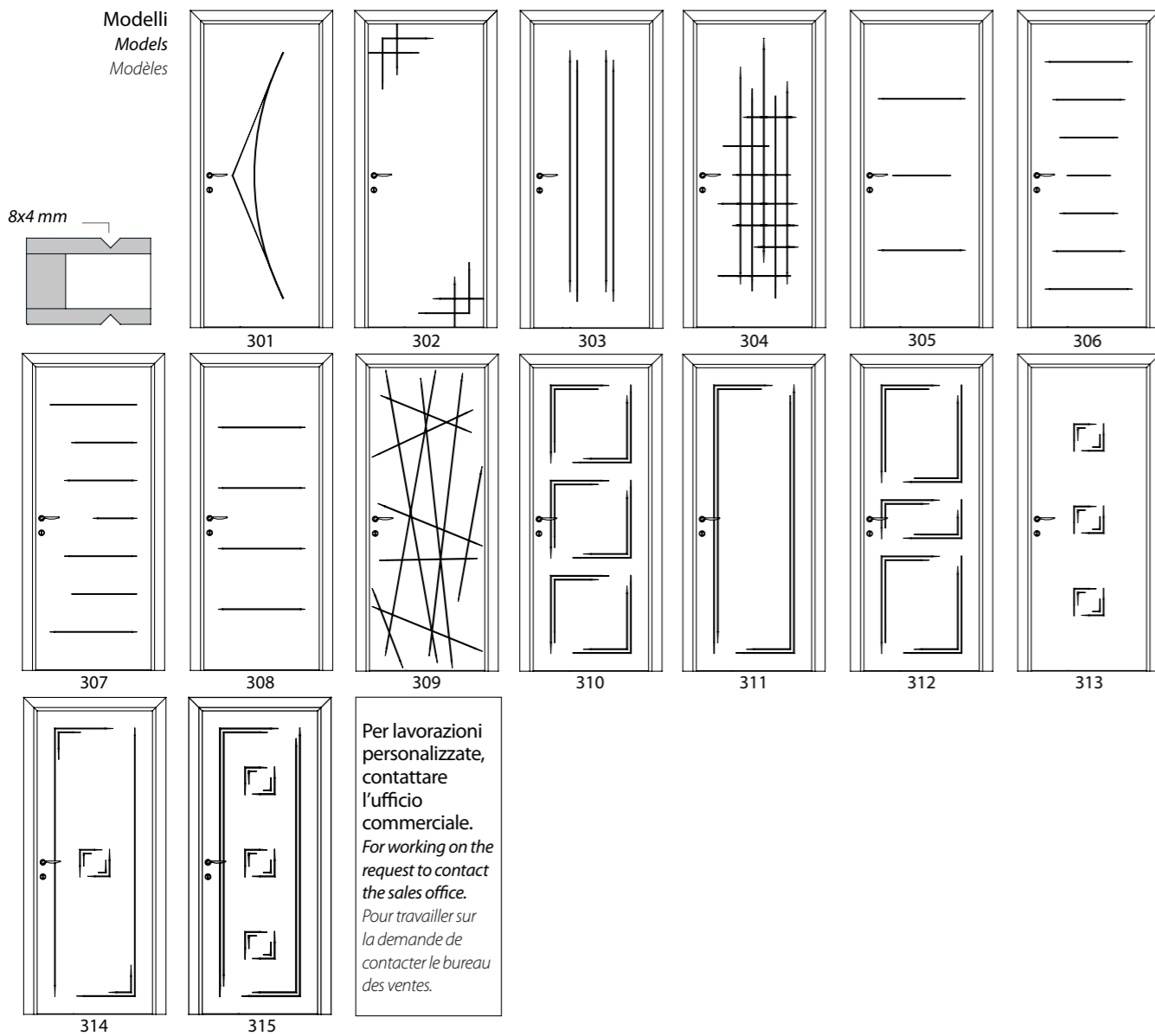

Imbotte - Raggio 10 con cerniera anuba (Standard)*
Door jamb - Radius 10 with anuba hinge (Standard)*
Intrados - Rayon 10 avec charnière anuba (Standard)*

Scopri gli imbotti opzionali disponibili a pag. 196
Discover the other optional upholstery available on p. 196
Découvrez les autres selleries optionnelles disponibles p. 196

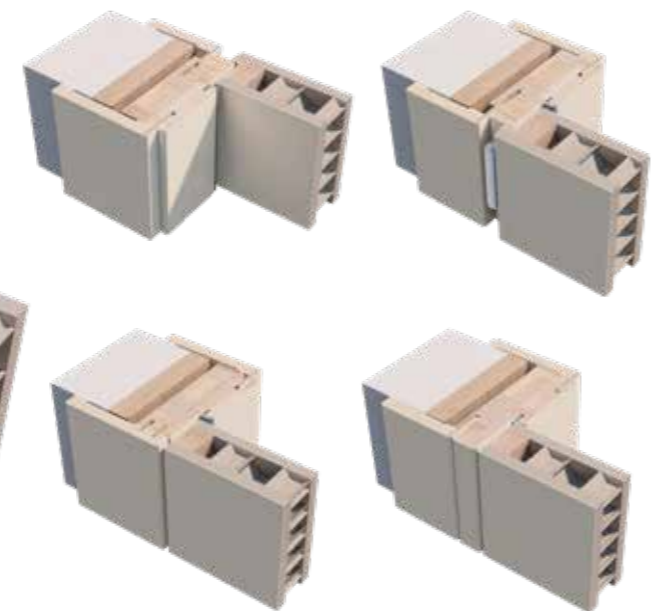
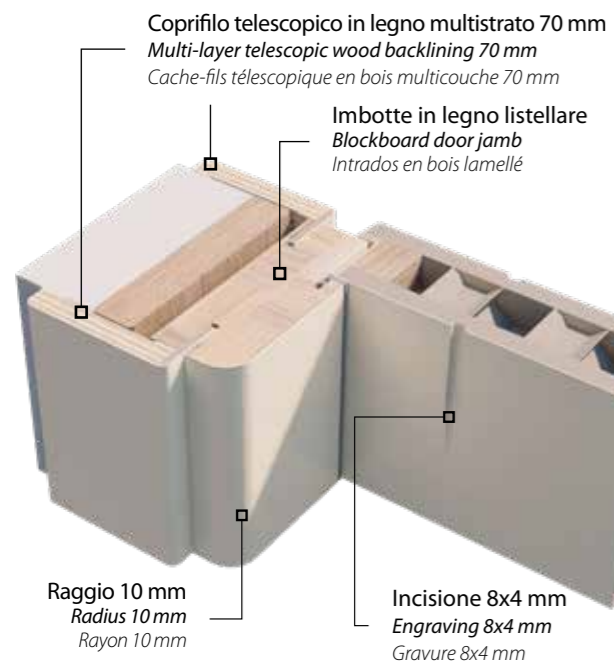

Laccato colori standard
Lacquered standard colors
Couleurs standard laqués

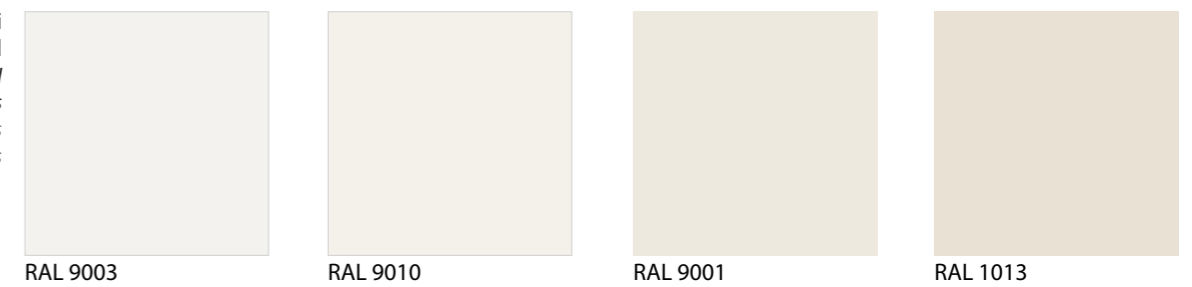

RAL (opzionale)
RAL (optional)
RAL (sur demande)

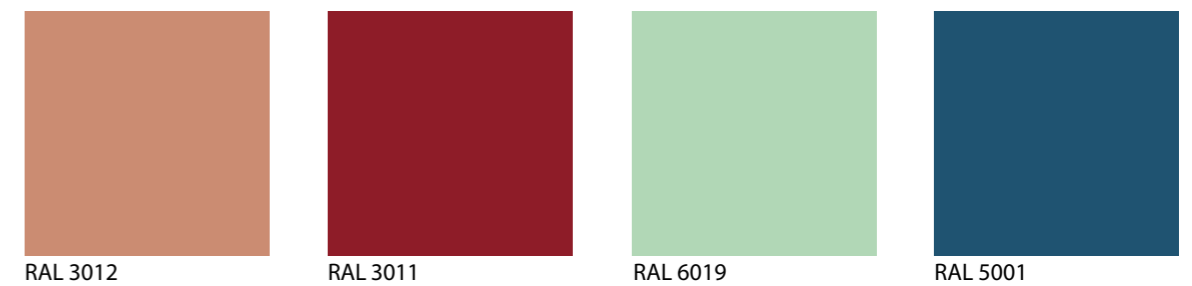
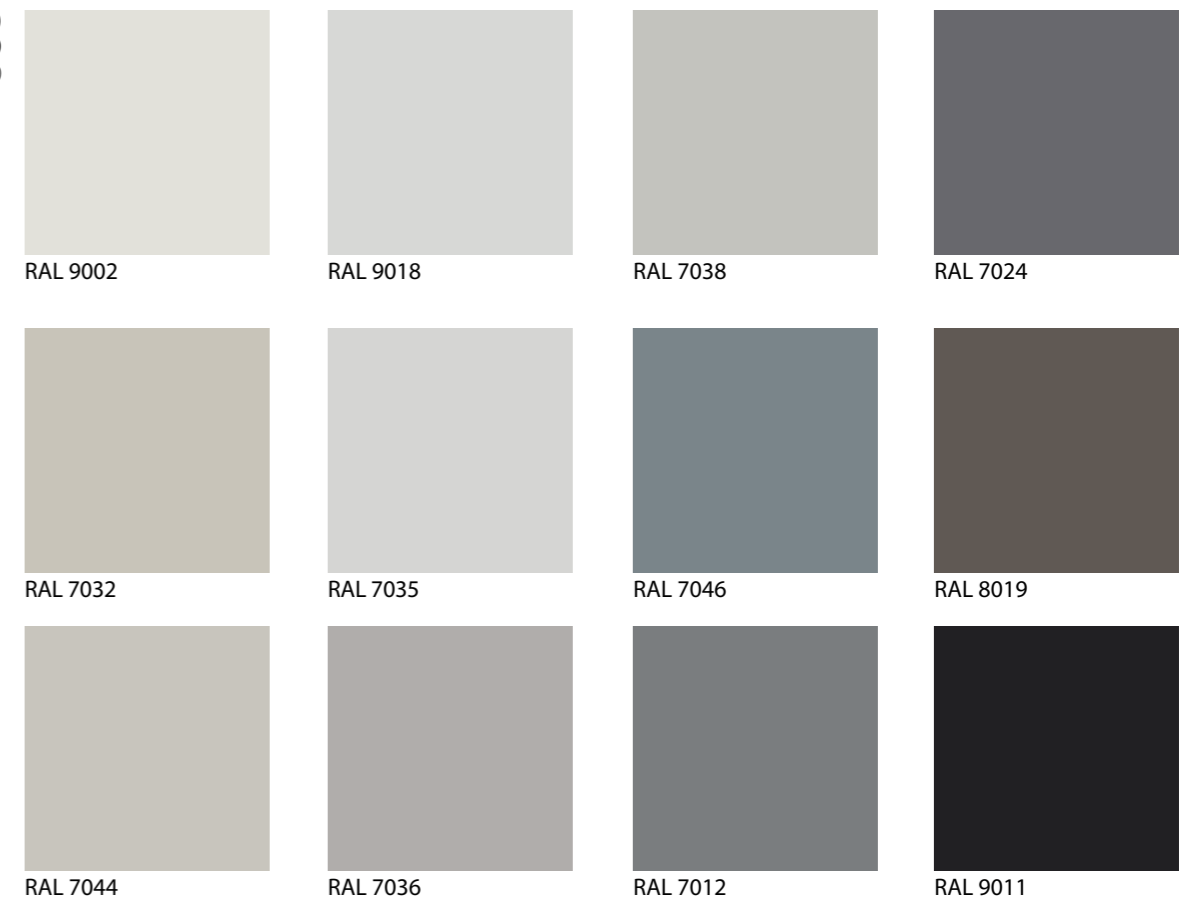

Verificare su mazzetta i colori reali, quelli riportati sul presente catalogo sono puramente indicativi
Check wad of real colors, as shown in this catalog are purely indicative
Vérifiez liasse de couleurs réelles, comme indiqué dans ce catalogue sont purement indicatives



Giochi di luce

Giochi di luce

Il tema delle incisioni trova nella collezione STILE la sua massima espressione decorativa. La finitura laccata della porta tamburata con imbotte in listellare si anima nel gioco di luci ed ombre generate dalla sofisticata lavorazione superficiale. Eleganza e innovazione si incontrano per regalare una porta di elevato valore estetico e funzionale, nata per arredare con gusto gli ambienti dell'abitare contemporaneo.

Play of light

The theme of the engravings finds its maximum decorative expression in the STILE collection. The lacquered finish of the honeycomb door with blockboard intrados comes alive in the play of light and shadow generated by the sophisticated surface processing. Elegance and innovation come together to give a door of high aesthetic and functional value, created to furnish contemporary living environments with taste.

Jeu de lumière

Le thème des gravures trouve son expression décorative maximale dans la collection STILE. La finition laquée de la porte en nid d'abeille avec intrados en latté prend vie dans le jeu d'ombre et de lumière généré par le traitement de surface sophistiqué. Élégance et innovation se rencontrent pour donner une porte de haute valeur esthétique et fonctionnelle, créée pour meubler avec goût les espaces de vie contemporains.

352 Laccato RAL 5001, imbotte Raggio 2
Lacquered RAL 5001, Radius 2 blockboard
Laqué RAL 5001, bâti Rayon 2



354 Laccato RAL 3012, imbotte Raggio 2
Lacquered RAL 3012, Radius 2 blockboard
Laqué RAL 3012, bâti Rayon 2



356 Laccato RAL 7038, imbotte Raggio 2
Lacquered RAL 7038, Radius 2 blockboard
Laqué RAL 7038, bâti Rayon 2



359 Laccato RAL 9003, imbotte Raggio 2
Lacquered RAL 9003, Radius 2 blockboard
Laqué RAL 9003, bâti Rayon 2



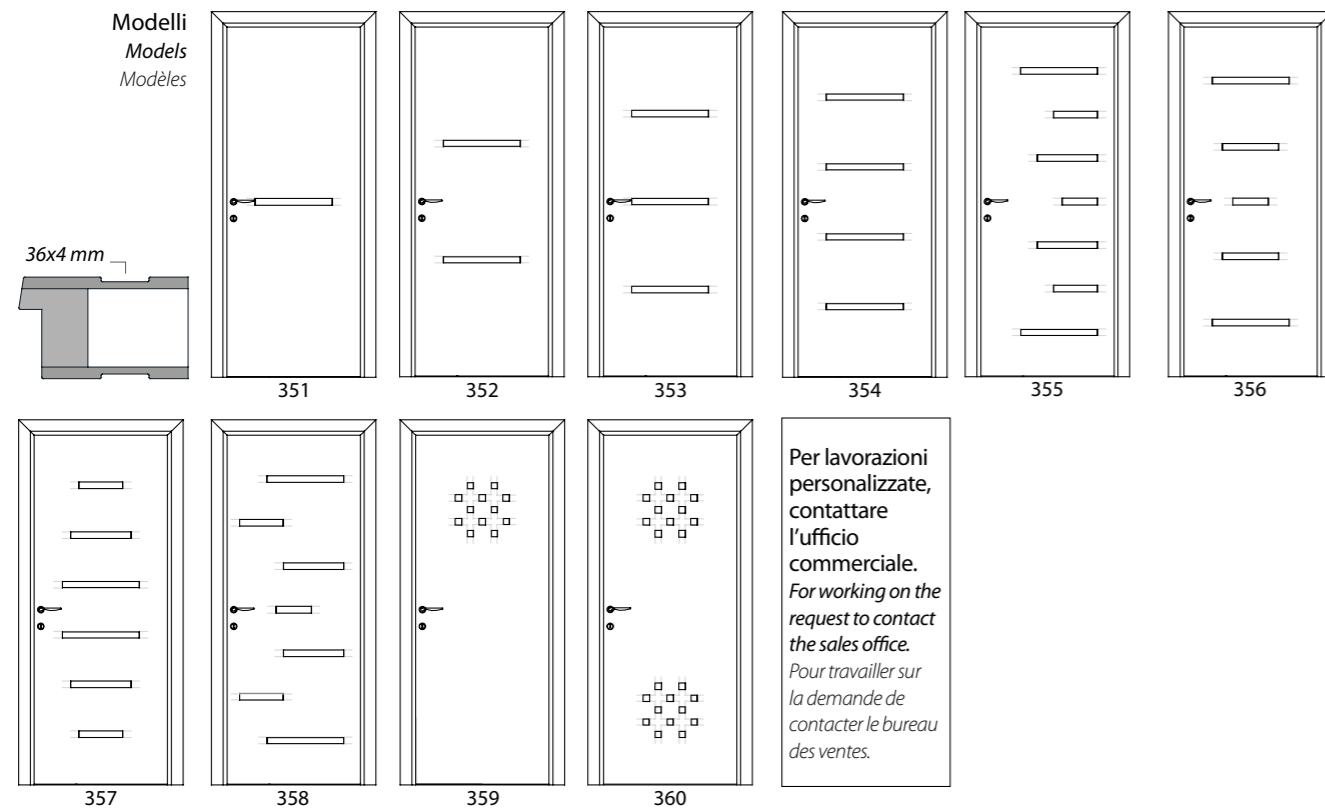

Imbotte - Raggio 10 con cerniera anuba (Standard)*
Door jamb - Radius 10 with anuba hinge (Standard)*
Intrados - Rayon 10 avec charnière anuba (Standard)*

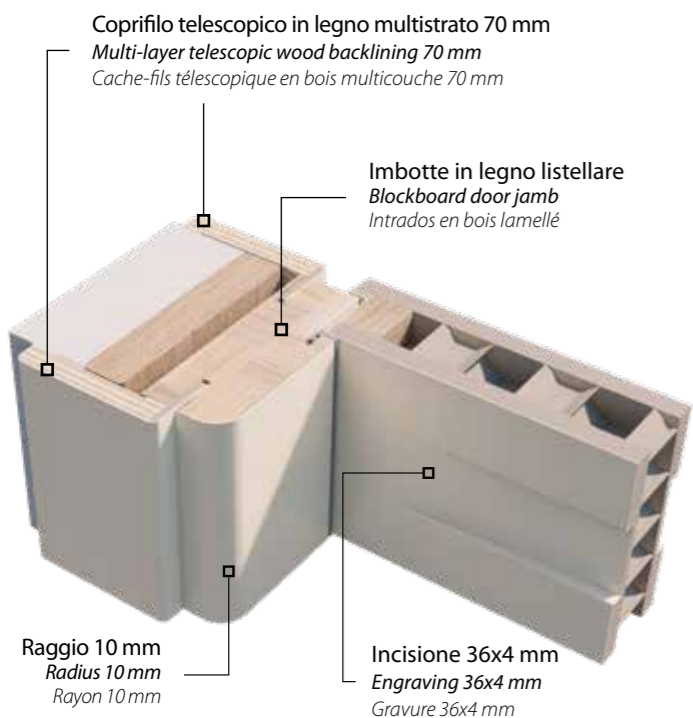

Scopri gli imbotti opzionali disponibili a pag. 196
Discover the other optional upholstery available on p. 196
Découvrez les autres selleries optionnelles disponibles p. 196

Laccato colori standard
Lacquered standard colors
Couleurs standard laqués



RAL (opzionale)
RAL (optional)
RAL (sur demande)

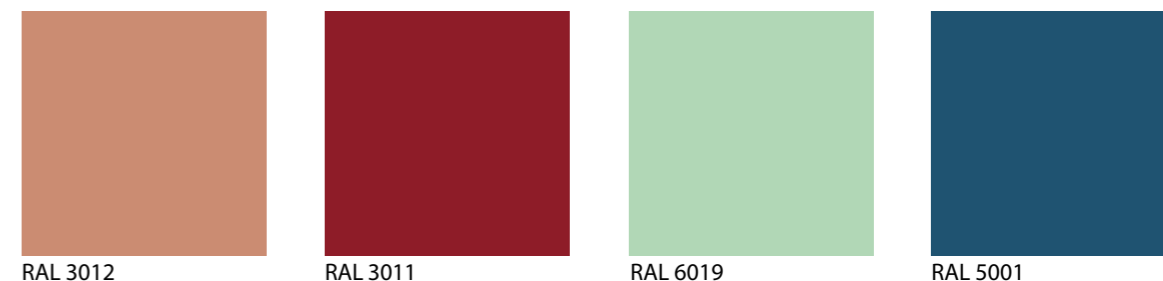
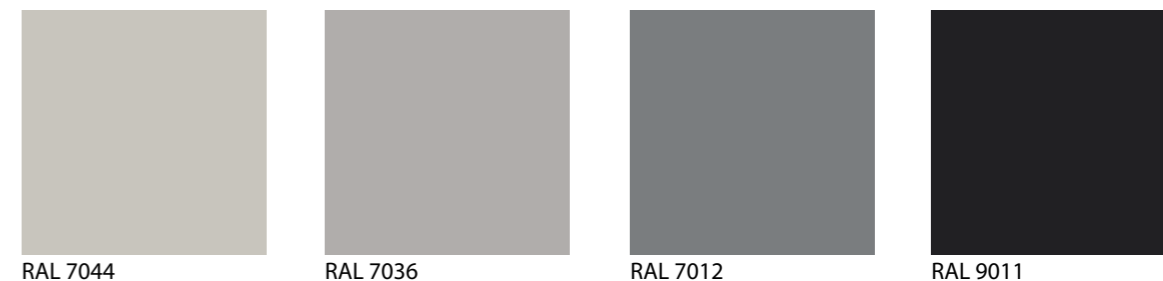
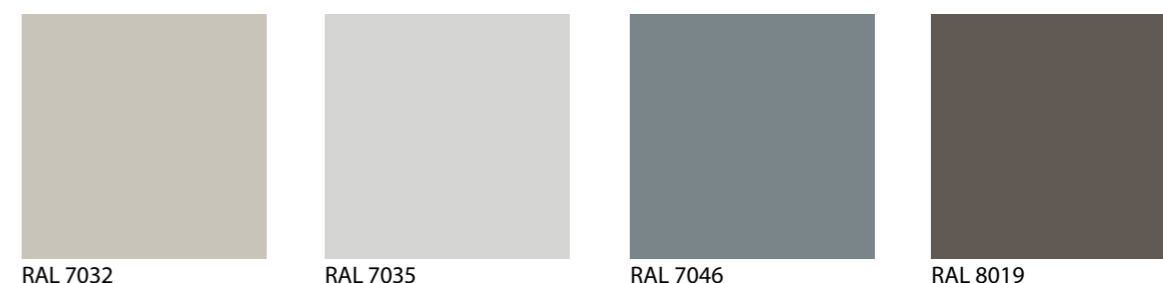
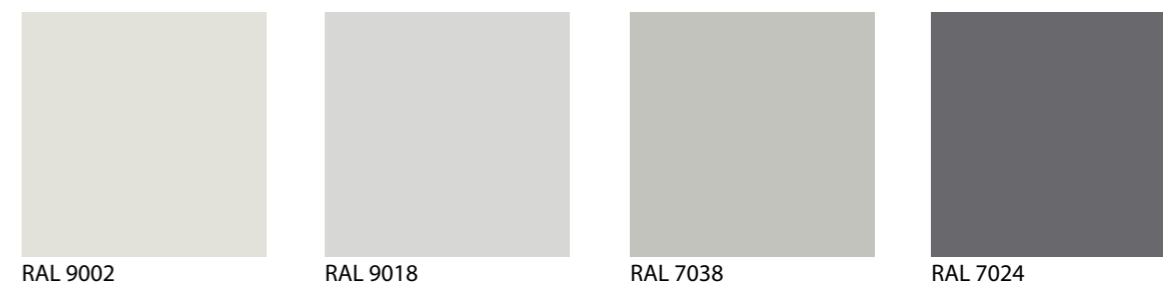

Verificare su mazzetta i colori reali, quelli riportati sul presente catalogo sono puramente indicativi
Check wad of real colors, as shown in this catalog are purely indicative
Vérifiez liasse de couleurs réelles, comme indiqué dans ce catalogue sont purement indicatives

DUAL

Superfici vibranti

Superfici vibranti

L'alternanza di superfici in essenza laccate lisce o sabbiate consente di ottenere un effetto che esalta il gioco delle incisioni donando alla porta un aspetto vibrante alla luce. L'effetto è applicabile a tutti i modelli e tutte le colorazioni, sia con venatura orizzontale che verticale.

Vibrating surfaces

The alternation of smooth or sandblasted lacquered wood surfaces allows for an effect that enhances the play of the engravings, giving the door a vibrant appearance in the light. The effect is applicable to all models and all colors, both with horizontal and vertical grain.

Surfaces vibrantes

L'alternance de surfaces de bois laquées lisses ou sablées permet un effet qui renforce le jeu des gravures, donnant à la porte un aspect vibrant à la lumière. L'effet est applicable à tous les modèles et à toutes les couleurs, à la fois avec un grain horizontal et vertical.

SEGNO

STILE





Superfici vibranti

Leggiadra eleganza

Leggiadra eleganza

Un gesto gentile ma deciso che esalta le preziose superfici in essenza laccate e sabbiate a mano: una delicata incisione che si distingue per le eleganti estremità rese appuntite dalla particolare tecnica di lavorazione computerizzata rifinita a mano. L'affidabilità della serie di porte tamburate rivestite in legno e laccate di OTC DOORS si arricchisce di una nuova collezione pensata per valorizzare gli ambienti con un tocco di rinnovata originalità.

Graceful elegance

A gentle but decisive gesture that enhances the precious surfaces in lacquered and hand-sanded essence: a delicate engraving that stands out for the elegant ends made pointed by the particular hand-finished computerized processing technique. The reliability of the OTC DOORS series of wood-paneled and lacquered honeycomb doors is enriched with a new collection designed to enhance environments with a touch of renewed originality.

Élégance gracieuse

Un geste doux mais décisif qui met en valeur les surfaces précieuses en essence laquées et poncées à la main : une gravure délicate qui se distingue par les extrémités élégantes rendues pointues par la technique particulière de traitement informatisé finie à la main. La fiabilité de la série OTC DOORS de portes en nid d'abeille lambrissées et laquées s'enrichit d'une nouvelle collection conçue pour mettre en valeur les environnements avec une touche d'originalité renouvelée.



D97
DUAL
 sabbiato orizzontale
 Laccato RAL 7046
 Lacquered RAL 7046
 Laqué RAL 7046

Modelli
 Models
 Modèles

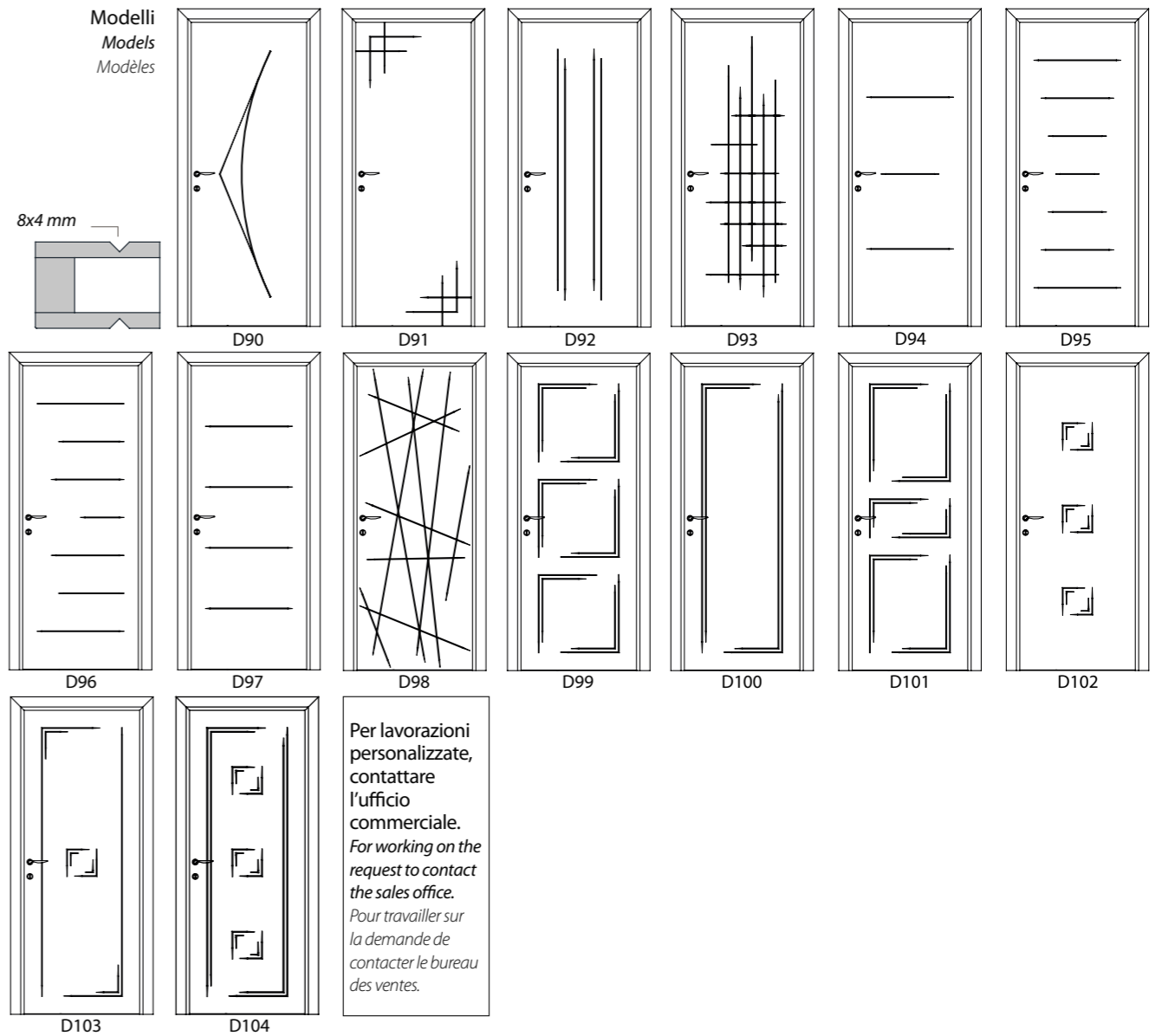

Imbotte Raggio 2 con cerniera a bilico
 Blackboard door jamb with pivot hinge
 Intrados en bois latté avec charnière à pivot

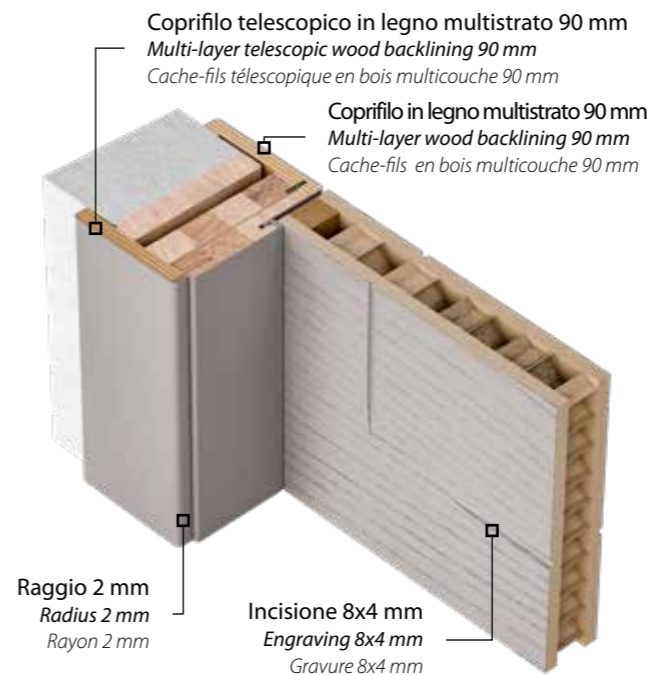

STILE DUAL



Superfici vibranti

Giochi di luce

Giochi di luce

Il tema delle incisioni trova nella collezione STILE la sua massima espressione decorativa. La finitura in essenza laccata e sabbiata a mano della porta tamburata con imbotte in listellare si anima nel gioco di luci ed ombre generate dalla sofisticata lavorazione superficiale. Eleganza e innovazione si incontrano per regalare una porta di elevato valore estetico e funzionale, nata per arredare con gusto gli ambienti dell'abitare contemporaneo.

Play of light

The theme of the engravings finds its maximum decorative expression in the STILE collection. The hand-sanded and lacquered essence finish of the honeycomb door with blockboard intrados comes alive in the play of light and shadow generated by the sophisticated surface processing. Elegance and innovation meet to give a door of high aesthetic and functional value, created to furnish contemporary living environments with taste.

Jeu de lumière

Le thème des gravures trouve son expression décorative maximale dans la collection STILE. La finition essence poncée et laquée à la main de la porte en nid d'abeille avec intrados en latté prend vie dans le jeu d'ombre et de lumière généré par le traitement de surface sophistiqué. Élégance et innovation se rencontrent pour donner une porte de haute valeur esthétique et fonctionnelle, créée pour meubler les espaces de vie contemporains avec goût.



D109
DUAL
 sabbiato orizzontale
 Laccato RAL 7044
 Lacquered RAL 7044
 Laqué RAL 7044

Modelli
 Models
 Modèles

36x4 mm

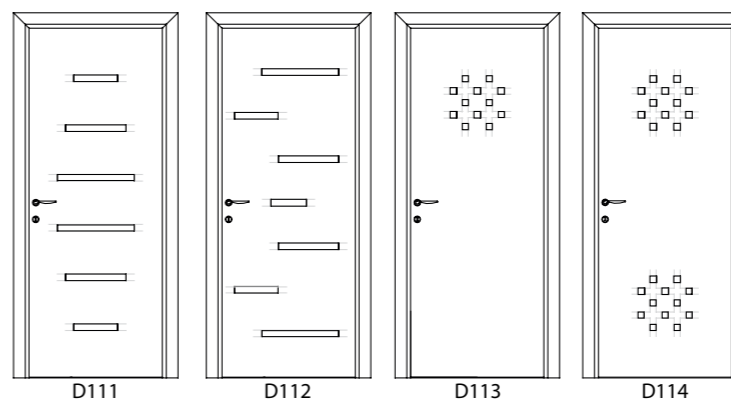
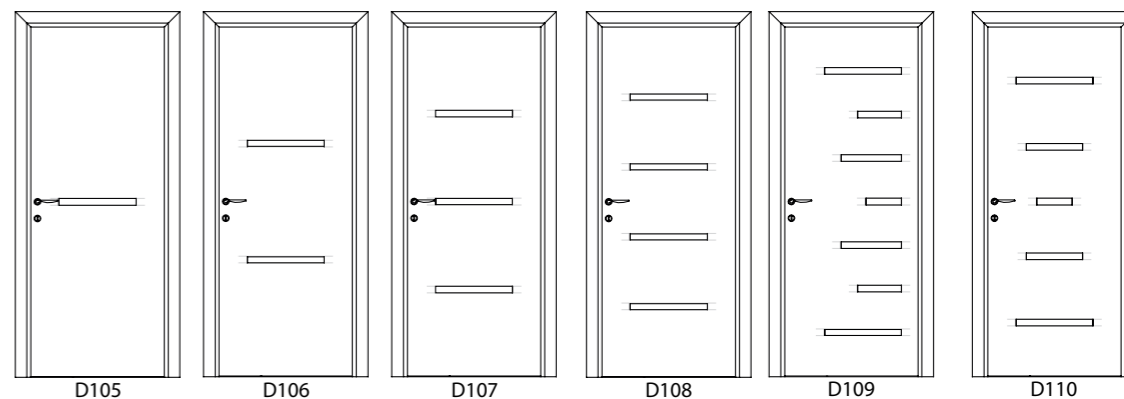
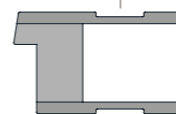

Per lavorazioni personalizzate, contattare l'ufficio commerciale.
 For working on the request to contact the sales office.
 Pour travailler sur la demande de contacter le bureau des ventes.

Imbotte Raggio 2 con cerniera a bilico

Blackboard door jamb with pivot hinge
Intrados en bois latté avec charnière à pivot

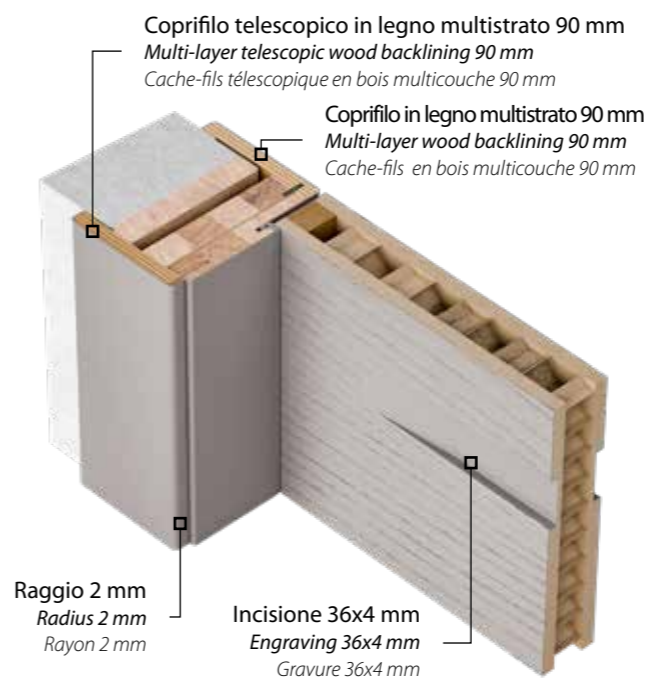

MODERN
DUAL



Superfici vibranti

Fascino e armonia

Fascino e armonia

MODERN, l'alternanza tra la trama del legno e la purezza della laccatura, regolata da un gioco geometrico di linee incise, consente di creare opere destinate ad arricchire gli ambienti del vivere contemporaneo.

Charm and harmony

MODERN, the alternation between the texture of the wood and the purity of the lacquering regulated by a geometric play of incised lines, allows the creation of works destined to enrich the environments of contemporary living.

Charme et harmonie

MODERN, l'alternance entre la texture du bois et la pureté du laquage régulée par un jeu géométrique de lignes incisées, permet la création d'œuvres destinées à enrichir les environnements de la vie contemporaine.

Interni Coordinati

Armonia ed eleganza sono alla base del concetto proposto da OTC DOORS per coordinare la porta blindata con il resto delle porte interne, grazie alla possibilità di avere il pannello interno, porte tuttovetro, coprifili e battiscopa delle stesse finiture della collezione DUAL.

Harmony and elegance are the basis of the concept proposed by OTC DOORS to coordinate the security door with the rest of the internal doors, thanks to the possibility of having the internal panel, all glass doors, backlining and skirting of the same finishes as the DUAL collection.

L'harmonie et l'élégance sont à la base du concept proposé par OTC DOORS pour coordonner la porte blindée avec le reste des portes intérieures, grâce à la possibilité d'avoir le panneau intérieur, portes tout en verre, cache-fils et plinthe des mêmes finitions que la collection DUAL.

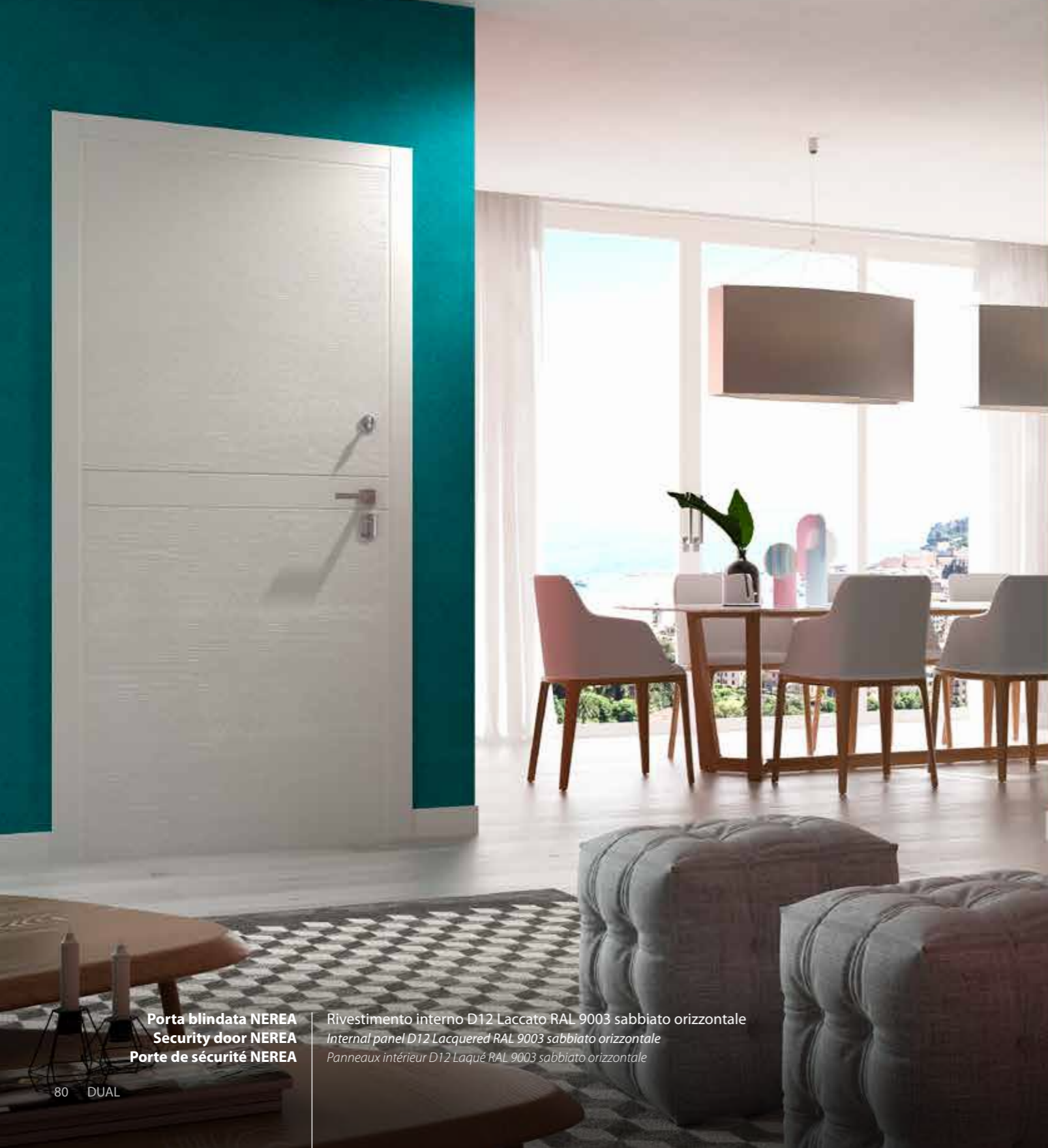

Porta blindata NEREA
Security door NEREA
Porte de sécurité NEREA

Rivestimento interno D12 Laccato RAL 9003 sabbato orizzontale
Internal panel D12 Lacquered RAL 9003 sabbato orizzontale
Panneaux intérieur D12 Laqué RAL 9003 sabbato orizzontale

D12
DUAL
sabbato orizzontale

Laccato RAL 9003
Lacquered RAL 9003
Laqué RAL 9003

D12
DUAL
sabbato orizzontale

Laccato RAL 9003
Lacquered RAL 9003
Laqué RAL 9003



D14
DUAL
sabbato orizzontale
Laccato RAL 7046
Lacquered RAL 7046
Laqué RAL 7046



D02
DUAL
sabbato orizzontale
Laccato RAL 7044
Lacquered RAL 7044
Laqué RAL 7044

Interni Coordinati

Armonia ed eleganza sono alla base del concetto proposto da OTC DOORS per coordinare la porta blindata con il resto delle porte interne, grazie alla possibilità di avere il pannello interno, porte tuttovetro, coprifili e battiscopa delle stesse finiture della collezione DUAL.

Harmony and elegance are the basis of the concept proposed by OTC DOORS to coordinate the security door with the rest of the internal doors, thanks to the possibility of having the internal panel, all glass doors, backlining and skirting of the same finishes as the DUAL collection.

L'harmonie et l'élégance sont à la base du concept proposé par OTC DOORS pour coordonner la porte blindée avec le reste des portes intérieures, grâce à la possibilité d'avoir le panneau intérieur, portes tout en verre, cache-fils et plinthe des mêmes finitions que la collection DUAL.

TUTTO VETRO

Laccato RAL 9010, scorrevole a scomparsa, vetro Tramonto
Lacquered RAL 9010, fully-retracting sliding door, Tramonto glass
Laqué RAL 9010, porte coulissante escamotable, verre Tramonto

**D11
DUAL**
sabbiato orizzontale

Laccato RAL 9010
Lacquered RAL 9010
Laqué RAL 9010

**Porta blindata NEREA
Security door NEREA
Porte de sécurité NEREA**

Rivestimento interno D11 Laccato RAL 9010 sabbiato orizzontale
Internal panel D11 Lacquered RAL 9010 sabbiato orizzontale
Panneaux intérieur D11 Laqué RAL 9010 sabbiato orizzontale



**D13
DUAL
sabiato verticale**

Laccato RAL 7038
Lacquered RAL 7038
Laqué RAL 7038

**D13
DUAL
sabiato verticale**

Laccato RAL 7038
Lacquered RAL 7038
Laqué RAL 7038

**Porta blindata NEREA
Security door NEREA
Porte de sécurité NEREA**

Rivestimento interno D13 Laccato RAL 7038 sabbiato verticale
Internal panel D13 Lacquered RAL 7038 sabbiato verticale
Panneaux intérieur D13 Laqué RAL 7038 sabbiato verticale



D10
DUAL
 sabbiato orizzontale
 Laccato RAL 7035
 Lacquered RAL 7035
 Laqué RAL 7035

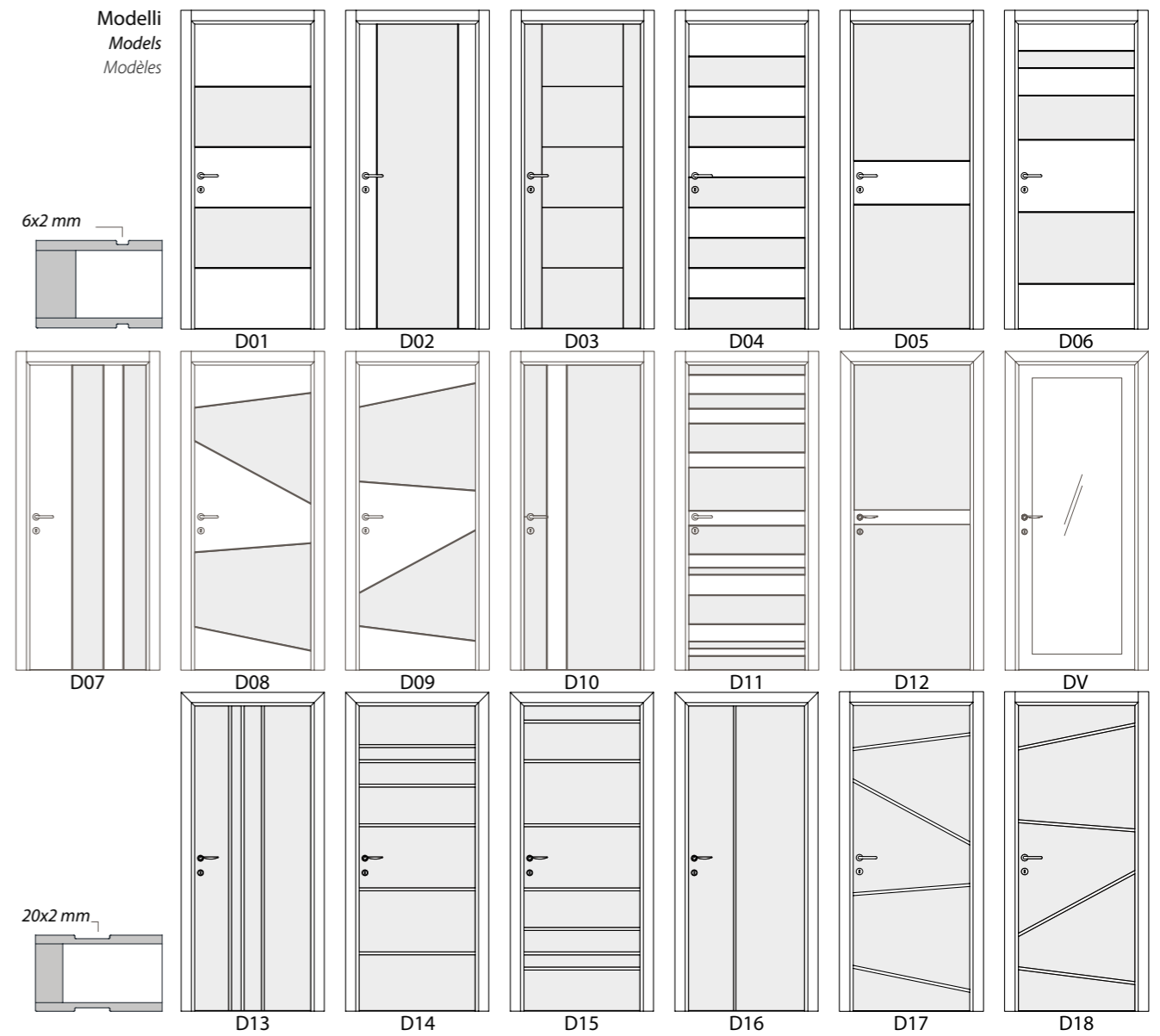

Imbotte Raggio 2 con cerniera a bilico
Blackboard door jamb with pivot hinge
Intrados en bois latté avec charnière à pivot

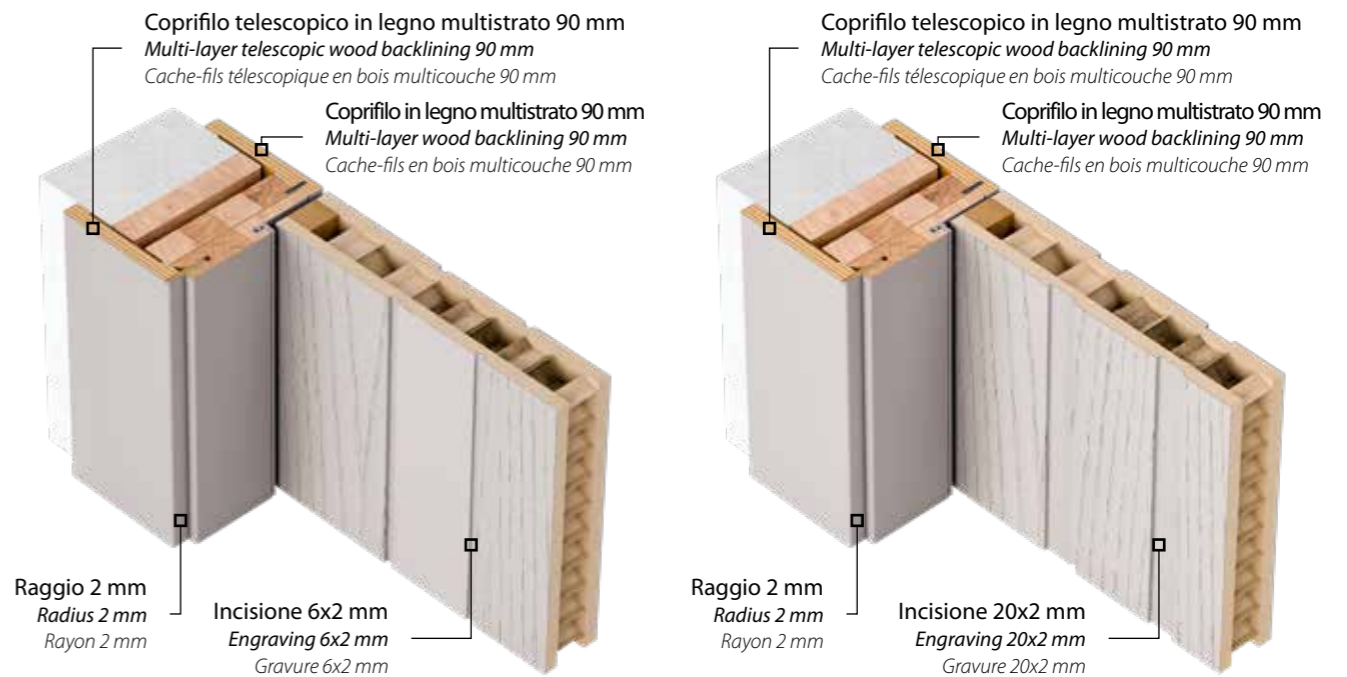

VINTAGE
DUAL



Superfici vibranti

Spiccata personalità

Spiccata personalità

Il gioco delle superfici laccate e in essenza obbedisce alle geometrie arrotondate che richiamano la grafica degli anni 70 reinterpretate in chiave contemporanea per una serie originale e ricercata.

Strong personality

The play of lacquered surfaces and in essence obeys the rounded geometries that recall the graphics of the 70s reinterpreted in a contemporary key for an original and refined series.

Forte personnalité

Le jeu des surfaces laquées obéit essentiellement à des géométries arrondies qui rappellent le graphisme des années 70 réinterprété dans une touche contemporaine pour une série originale et raffinée.

Interni Coordinati

Armonia ed eleganza sono alla base del concetto proposto da OTC DOORS per coordinare la porta blindata con il resto delle porte interne, grazie alla possibilità di avere il pannello interno, porte tuttovetro, coprifili e battiscopa delle stesse finiture della collezione DUAL.

Harmony and elegance are the basis of the concept proposed by OTC DOORS to coordinate the security door with the rest of the internal doors, thanks to the possibility of having the internal panel, all glass doors, backlining and skirting of the same finishes as the DUAL collection.

L'harmonie et l'élégance sont à la base du concept proposé par OTC DOORS pour coordonner la porte blindée avec le reste des portes intérieures, grâce à la possibilité d'avoir le panneau intérieur, portes tout en verre, cache-fils et plinthe des mêmes finitions que la collection DUAL.



**D25
DUAL**
sabbaiato orizzontale

Laccato RAL 9002
Lacquered RAL 9002
Laqué RAL 9002

**Porta blindata NEREA
Security door NEREA
Porte de sécurité NEREA**

Rivestimento interno D25 Laccato RAL 9002 sabbaiato orizzontale
Internal panel D25 Lacquered RAL 9002 sabbaiato orizzontale
Panneaux intérieur D25 Laqué RAL 9002 sabbaiato orizzontale



D28
DUAL
sabbiato verticale

Laccato RAL 9018
Lacquered RAL 9018
Laqué RAL 9018

D29
DUAL
sabbiato verticale

Laccato RAL 9018
Lacquered RAL 9018
Laqué RAL 9018



D26
DUAL
 sabbiato verticale
 Laccato RAL 6019
 Lacquered RAL 6019
 Laqué RAL 6019

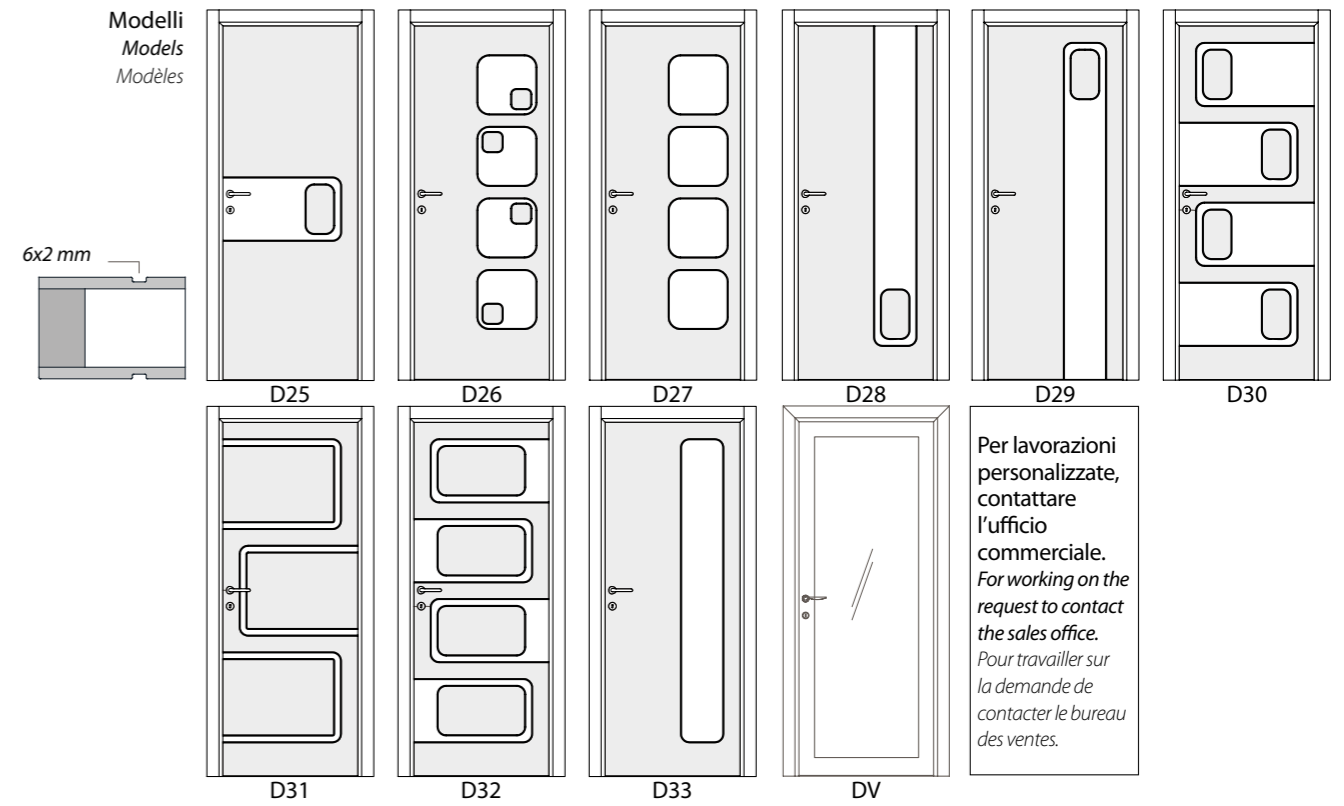

Imbotte Raggio 2 con cerniera a bilico

Blackboard door jamb with pivot hinge
Intrados en bois latté avec charnière à pivot

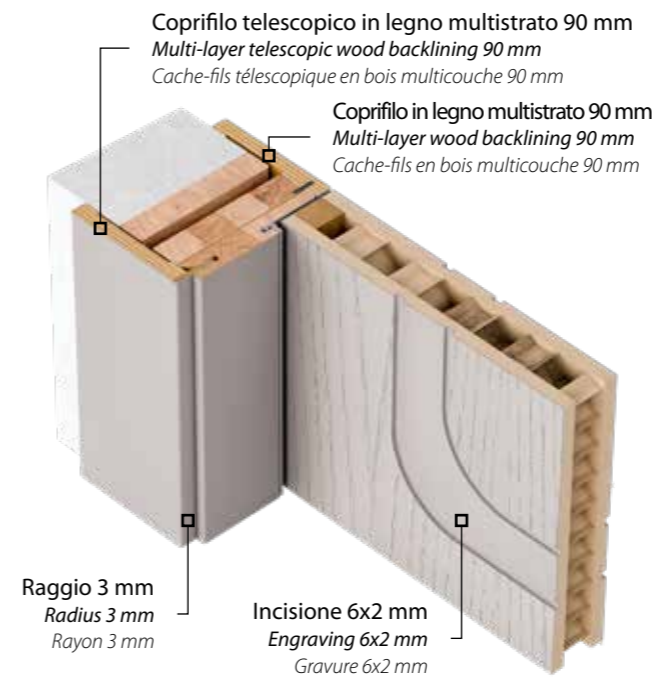



Superfici vibranti

Carattere e personalità

Carattere e personalità

Il classico e il moderno si incontrano per un design contemporaneo e ricercato. Le linee realizzate con incisione di alta precisione, a base quadrata, definiscono un nuovo modo di disegnare la porta, essenziale e decorativo al tempo stesso. TOSCA è la porta ideale per piccoli e grandi progetti.

Character and personality

The classic and the modern meet for a contemporary and sophisticated design. The lines made with high-precision engraving, with a square base, define a new way of drawing the door, essential and decorative at the same time. TOSCA is the ideal port for small and large projects.

Character and personality

Le classique et la rencontre moderne pour un design contemporain et sophistiqué. Les lignes faites avec gravure de haute précision, avec une base carrée, définissent une nouvelle façon de dessiner la porte, essentielle et décoratif dans le même temps. TOSCA est le port idéal pour petits et grands projets.

Interni Coordinati

Armonia ed eleganza sono alla base del concetto proposto da OTC DOORS per coordinare la porta blindata con il resto delle porte interne, grazie alla possibilità di avere il pannello interno, porte tuttovetro, coprifili e battiscopa delle stesse finiture della collezione DUAL.

Harmony and elegance are the basis of the concept proposed by OTC DOORS to coordinate the security door with the rest of the internal doors, thanks to the possibility of having the internal panel, all glass doors, backlining and skirting of the same finishes as the DUAL collection.

L'harmonie et l'élégance sont à la base du concept proposé par OTC DOORS pour coordonner la porte blindée avec le reste des portes intérieures, grâce à la possibilité d'avoir le panneau intérieur, portes tout en verre, cache-fils et plinthe des mêmes finitions que la collection DUAL.



TUTTO VETRO

Laccato RAL 9010, scorrevole a scomparsa, vetro Astratto blu
Lacquered RAL 9010, fully-retracting sliding door, Astratto blu glass
Laqué RAL 9010, porte coulissante escamotable, verre Astratto blu

**D44
DUAL
sabbiato orizzontale**

Laccato RAL 9010
Lacquered RAL 9010
Laqué RAL 9010

**Porta blindata NEREA
Security door NEREA
Porte de sécurité NEREA**

Rivestimento interno D44 Laccato RAL 9010 sabbiato orizzontale
Internal panel D44 Lacquered RAL 9010 sabbiato orizzontale
Panneaux intérieur D44 Laqué RAL 9010 sabbiato orizzontale



D49
DUAL
 sabbiato verticale
 Laccato RAL 7036
 Lacquered RAL 7036
 Laqué RAL 7036

Modelli "M"
 Models "M"
 Modèles "M"

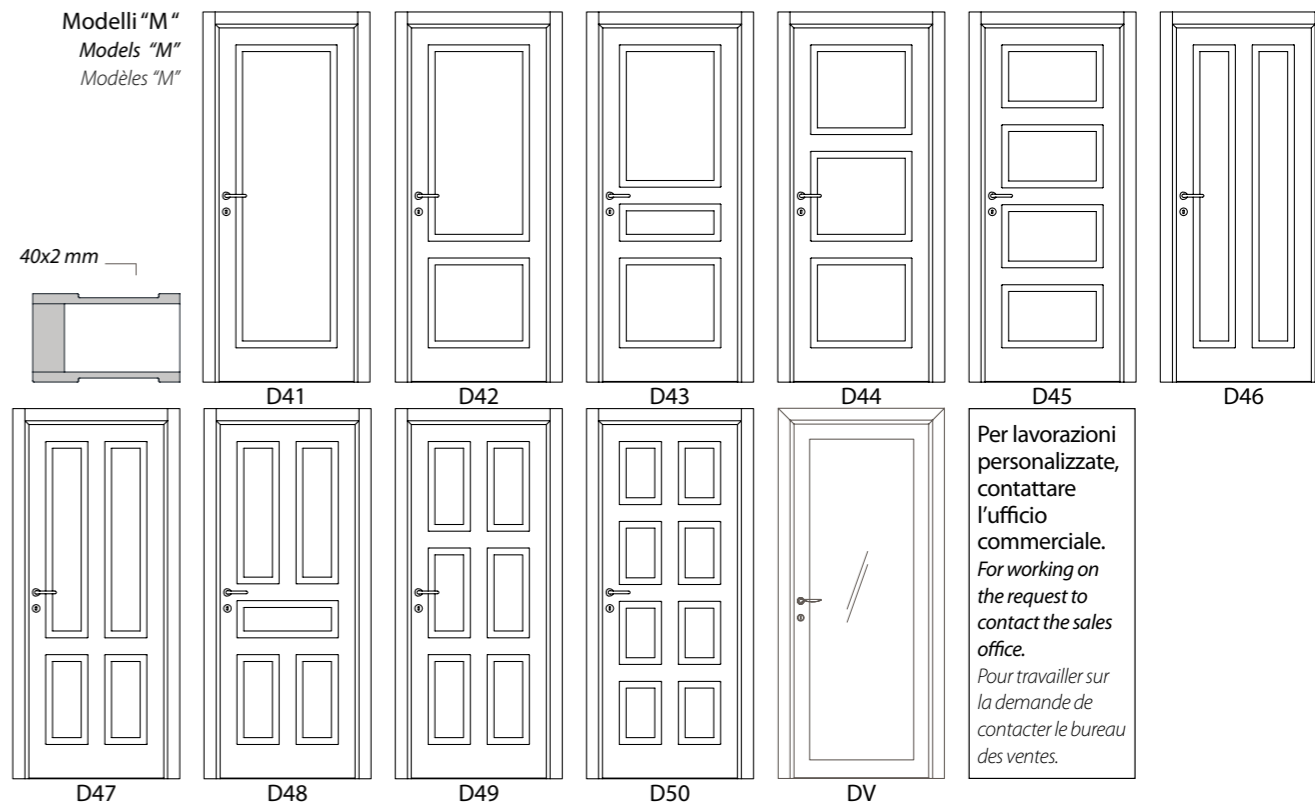

Imbotte Raggio 2 con cerniera a bilico

Blackboard door jamb with pivot hinge
 Intrados en bois latté avec charnière à pivot

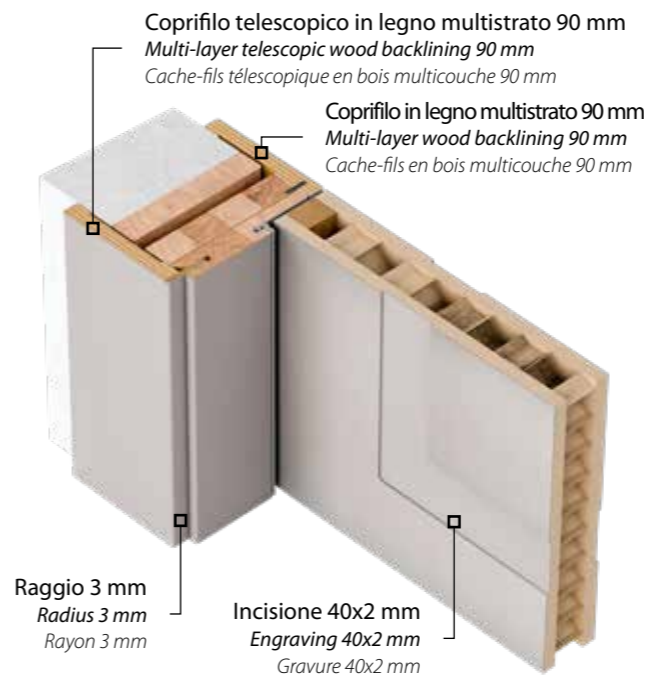



DUAL



Superfici vibranti

Delicata armonia

Delicata armonia

Le delicate incisioni che solcano la trama autentica del legno delle superfici laccate e sabbiate creano opere che uniscono eleganza e armonia per una serie senza tempo in grado di assecondare le esigenze dell'arredare contemporaneo.

Delicate harmony

The delicate engravings that ply the authentic texture of the wood of the sanded lacquered surfaces create works that combine elegance and harmony for a timeless series that can satisfy the needs of contemporary furnishing.

Délicate harmonie

Les gravures délicates qui imprègnent la texture authentique du bois des surfaces sablées créent des œuvres alliant élégance et harmonie pour une série intemporelle pouvant satisfaire les besoins du mobilier contemporain.



D56
DUAL
sabbiato orizzontale
Laccato RAL 9003
Lacquered RAL 9003
Laqué RAL 9003

D56
DUAL
sabbiato orizzontale
Laccato RAL 9003
Lacquered RAL 9003
Laqué RAL 9003



D63
DUAL
sabbiato verticale

Laccato RAL 9001
Lacquered RAL 9001
Laqué RAL 9001

Modelli
Models
Modèles

6x2 mm

D56 D57 D58 D59 D60 D61

D62 D63 D64 D65 D66 D67 D68

D69 D70 D71 DV D120 D121

D122 D123 D124 D125

D126 D127 D128

NEW

Imbotte Raggio 2 con cerniera a bilico
Blackboard door jamb with pivot hinge
Intrados en bois latté avec charnière à pivot

Coprifilo telescopico in legno multistrato 90 mm
Multi-layer telescopic wood backlining 90 mm
Cache-fils télescopique en bois multicouche 90 mm

Coprifilo in legno multistrato 90 mm
Multi-layer wood backlining 90 mm
Cache-fils en bois multicouche 90 mm

Raggio 3 mm
Radius 3 mm
Rayon 3 mm

Incisione 6x2 mm
Engraving 6x2 mm
Gravure 6x2 mm



DUAL



Superfici vibranti

Delicata armonia

Delicata armonia

Con segno deciso ma delicato, la trama autentica del legno è solcata dalle incisioni a V che valorizzano le superfici di una serie di grande successo ideale per arredare gli spazi del vivere contemporaneo.

Delicate harmony

With a decisive but delicate sign, the authentic texture of the wood is furrowed by V-shaped incisions that enhance the surfaces of a series of great success, ideal for furnishing contemporary living spaces.

Délicate harmonie

Avec un signe décisif mais délicat, la texture authentique du bois est sillonnée par des incisions en forme de V qui rehaussent les surfaces d'une série de succès, idéales pour l'aménagement d'espaces de vie contemporains.

Interni Coordinati

Armonia ed eleganza sono alla base del concetto proposto da OTC DOORS per coordinare la porta blindata con il resto delle porte interne, grazie alla possibilità di avere il pannello interno, porte tuttovetro, coprifili e battiscopa delle stesse finiture della collezione DUAL.

Harmony and elegance are the basis of the concept proposed by OTC DOORS to coordinate the security door with the rest of the internal doors, thanks to the possibility of having the internal panel, all glass doors, backlining and skirting of the same finishes as the DUAL collection.

L'harmonie et l'élégance sont à la base du concept proposé par OTC DOORS pour coordonner la porte blindée avec le reste des portes intérieures, grâce à la possibilité d'avoir le panneau intérieur, portes tout en verre, cache-fils et plinthe des mêmes finitions que la collection DUAL.

TUTTO VETRO

Laccato RAL 1019, scorrevole a scomparsa, vetro Alpaca
Lacquered RAL 1019, fully-retracting sliding door, Alpaca glass
Laqué RAL 1019, porte coulissante escamotable, verre transparentes Alpaca

D78 DUAL sabbiaio orizzontale

Laccato RAL 1019
Lacquered RAL 1019
Laqué RAL 1019

Porta blindata NEREA Security door NEREA Porte de sécurité NEREA

Rivestimento interno D78 Laccato RAL 1019 sabbiaio orizzontale
Internal panel D78 Lacquered RAL 1019 sabbiaio orizzontale
Panneaux intérieur D78 Laqué RAL 1019 sabbiaio orizzontale



Modelli "V"
Models "V"
Modèles "V"

8x4 mm

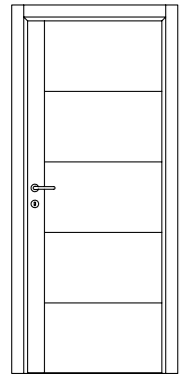
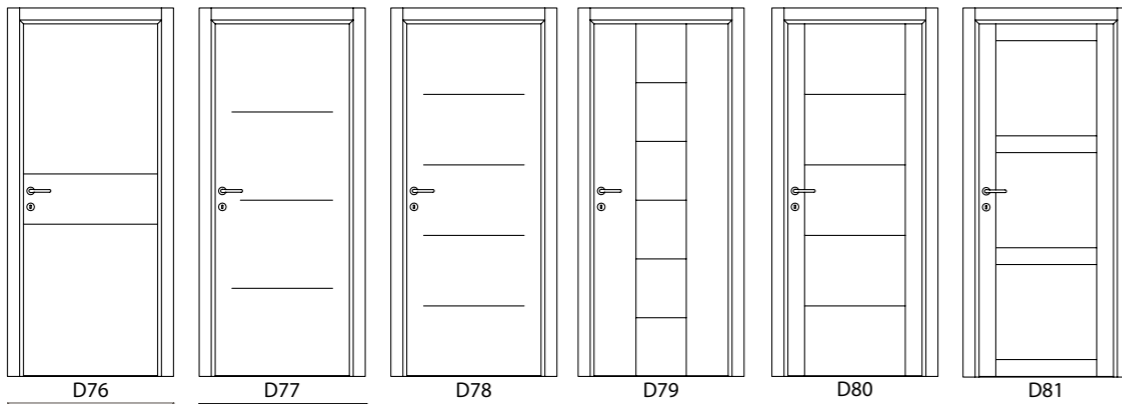
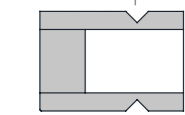

Per lavorazioni personalizzate, contattare l'ufficio commerciale.
For working on the request to contact the sales office.
Pour travailler sur la demande de contacter le bureau des ventes.

D82

DV

Imbotte Raggio 2 con cerniera a bilico

Blackboard door jamb with pivot hinge

Intrados en bois latté avec charnière à pivot

Coprifilo telescopico in legno multistrato 90 mm

Multi-layer telescopic wood backlining 90 mm

Cache-fils télescopique en bois multicouche 90 mm

Coprifilo in legno multistrato 90 mm

Multi-layer wood backlining 90 mm

Cache-fils en bois multicouche 90 mm



Raggio 3 mm

Radius 3 mm

Rayon 3 mm

Incisione 8x4 mm

Engraving 8x4 mm

Gravure 8x4 mm

Laccato colori standard
Lacquered standard colors
Couleurs standard laqués

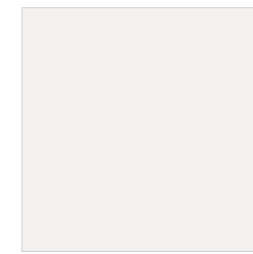

RAL 9003

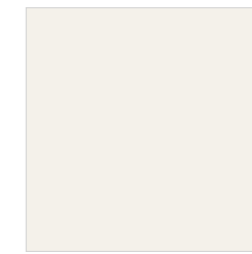

RAL 9010

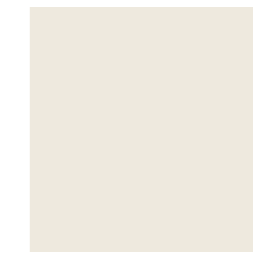

RAL 9001



RAL 1013

RAL (opzionale)
RAL (optional)
RAL (sur demande)



RAL 9002



RAL 9018



RAL 7038



RAL 7024



RAL 7032



RAL 7035



RAL 7046



RAL 8019



RAL 7044



RAL 7036



RAL 7012



RAL 9011



RAL 3012



RAL 3011



RAL 6019



RAL 5001



Altri colori RAL su richiesta

Other RAL colors on request

Autres couleurs RAL sur demande



Finitura opaca (di serie)

Matte finish (standard)

Finition mate (standard)



Finitura lucida (opzionale)

Glossy finish (optional)

Finition brillante (sur demande)

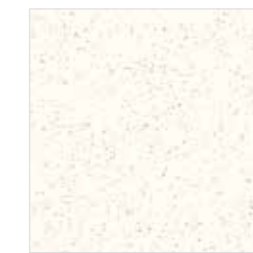

Finit. goffrato fine (opzionale)

Finish embossed (optional)

Terminer en relief (sur demande)

Verificare su mazzetta i colori reali, quelli riportati sul presente catalogo sono puramente indicativi

Check wad of real colors, as shown in this catalog are purely indicative

Vérifiez liasse de couleurs réelles, comme indiqué dans ce catalogue sont purement indicatives



TOSCA



Carattere e personalità

Carattere e personalità

Il classico e il moderno si incontrano per un design contemporaneo e ricercato. Le linee realizzate con incisione di alta precisione, a base quadrata, definiscono un nuovo modo di disegnare la porta, essenziale e decorativo al tempo stesso. TOSCA è la porta ideale per piccoli e grandi progetti.

Character and personality

The classic and the modern meet for a contemporary and sophisticated design. The lines made with high-precision engraving, with a square base, define a new way of drawing the door, essential and decorative at the same time. TOSCA is the ideal port for small and large projects.

Character and personality

Le classique et la rencontre moderne pour un design contemporain et sophistiqué. Les lignes faites avec gravure de haute précision, avec une base carrée, définissent une nouvelle façon de dessiner la porte, essentielle et décoratif dans le même temps. TOSCA est le port idéal pour petits et grands projets.

Interni Coordinati

Armonia ed eleganza sono alla base del concetto proposto da OTC DOORS per coordinare la porta blindata con il resto delle porte interne, grazie alla possibilità di avere il pannello interno, porte tuttovetro, coprifili e battiscopa delle stesse finiture della collezione TOSCA.

Harmony and elegance are the basis of the concept proposed by OTC DOORS to coordinate the security door with the rest of the internal doors, thanks to the possibility of having the internal panel, all glass doors, backlining and skirting of the same finishes as the TOSCA collection.

L'harmonie et l'élégance sont à la base du concept proposé par OTC DOORS pour coordonner la porte blindée avec le reste des portes intérieures, grâce à la possibilité d'avoir le panneau intérieur, portes tout en verre, cache-fils et plinthe des mêmes finitions que la collection TOSCA.

TUTTOVETRO

Laccato RAL 7036, scorrevole a scomparsa, vetro Mondrian
Lacquered RAL 7036, fully-retracting sliding door, Mondrian glass
Laqué RAL 7036, porte coulissante escamotable, verre Mondrian

M03

Laccato RAL 7036, imbottite Raggio 2
Lacquered RAL 7036, Raggio 2 blockboard
Laqué RAL 7036, bâti Rayon 2

Porta blindata NEREA
Security door NEREA
Porte de sécurité NEREA

Rivestimento interno M03 Laccato Ral 7036
Internal panel M03 Lacquered RAL 7036
Panneaux intérieur M03 Laqué RAL 7036



M07

Laccato RAL 7032, imbotte Raggio 2
Lacquered RAL 7032, Radius 2 blockboard
Laqué RAL 7032, bâti Rayon 2

TUTTO VETRO

Laccato RAL 7032, porta a battente, vetro Bar Code
Lacquered RAL 7032, hinged door, Bar Code glass
Laqué RAL 7032, porte battante, verre Bar Code



M04

Laccato RAL 9010, imbotte Raggio 2
Lacquered RAL 9010, Radius 2 blockboard
Laqué RAL 9010, bâti Rayon 2



TUTTO VETRO

Laccato RAL 8019, porta a battente, vetro Graffiti fucsia
Lacquered RAL 8019, hinged door, Graffiti fucsia glass
Laqué RAL 8019, porte battante, verre Graffiti fucsia

M09

Laccato RAL 8019, imbottito Raggio 2
Lacquered RAL 8019, Radius 2 blockboard
Laqué RAL 8019, bâti Rayon



222 Laccato RAL 9003
Lacquered RAL 9003
Laqué RAL 9003



225 Laccato RAL 6019
Lacquered RAL 6019
Laqué RAL 6019



221 Laccato RAL 1013
Lacquered RAL 1013
Laqué RAL 1013

Serie LPC

Modelli
Models
Modèles

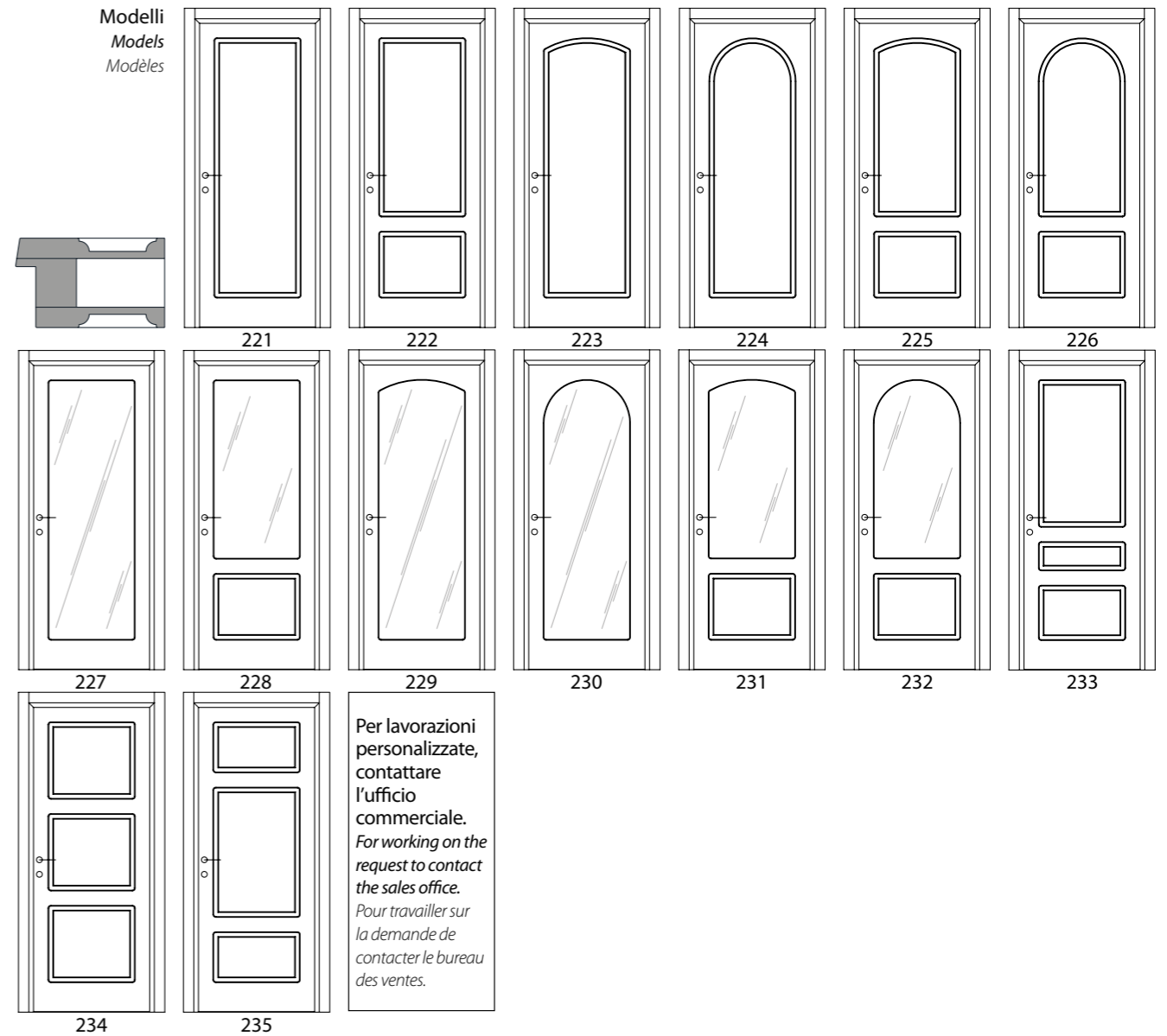

Per lavorazioni personalizzate, contattare l'ufficio commerciale.
For working on the request to contact the sales office.
Pour travailler sur la demande de contacter le bureau des ventes.

Imbotte - Raggio 10 con cerniera anuba (Standard)*
Door jamb - Radius 10 with anuba hinge (Standard)*
Intrados - Rayon 10 avec charnière anuba (Standard)*

Scopri gli imbotti opzionali disponibili a pag. 196
Discover the other optional upholstery available on p. 196
Découvrez les autres selleries optionnelles disponibles p. 196

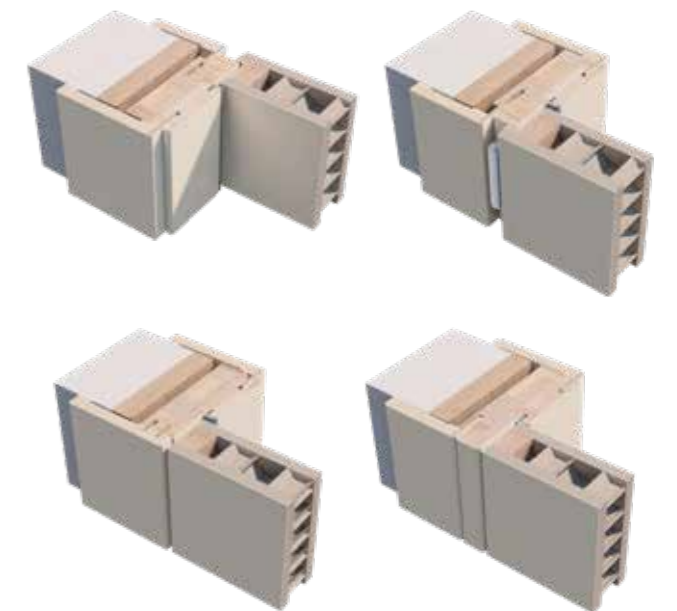
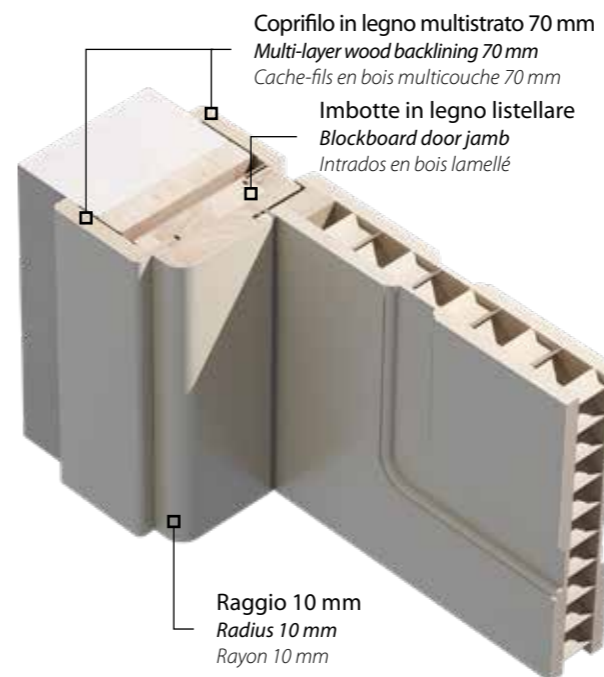

Modelli "M"
Models "M"
Modèles "M"

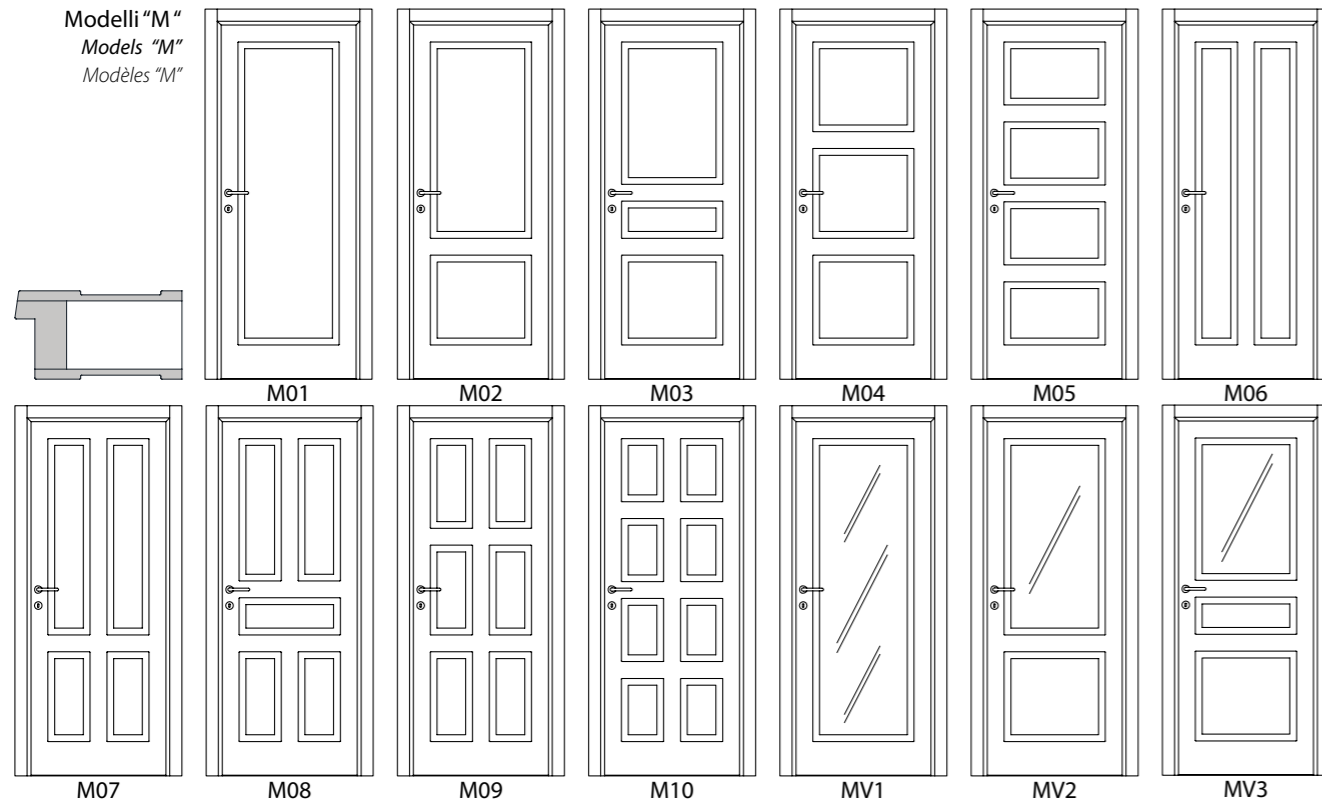

Imbotte - Raggio 10 con cerniera anuba (Standard)*
Door jamb - Radius 10 with anuba hinge (Standard)*
Intrados - Rayon 10 avec charnière anuba (Standard)*

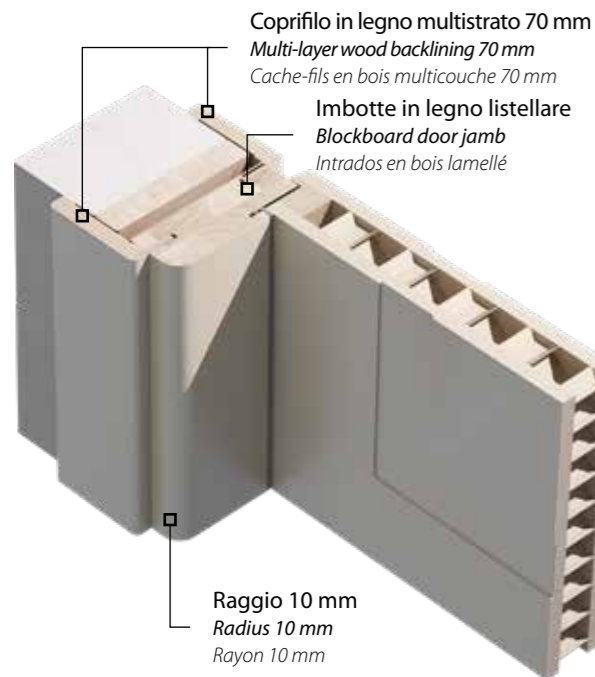

Scopri gli imbotti opzionali disponibili a pag. 196
Discover the other optional upholstery available on p. 196
Découvrez les autres selleries optionnelles disponibles p. 196

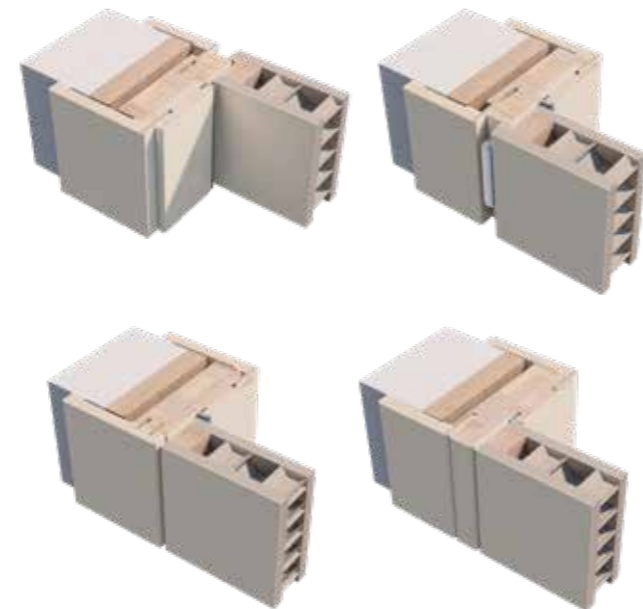

Laccato colori standard
Lacquered standard colors
Couleurs standard laqués



RAL 9003

RAL 9010

RAL 9001

RAL 1013

RAL (opzionale)
RAL (optional)
RAL (sur demande)



RAL 9002

RAL 9018

RAL 7038

RAL 7024



RAL 7032

RAL 7035

RAL 7046

RAL 8019



RAL 7044

RAL 7036

RAL 7012

RAL 9011



RAL 3012

RAL 3011

RAL 6019

RAL 5001



Altri colori RAL su richiesta
Other RAL colors on request
Autres couleurs RAL sur demande



Finitura opaca (di serie)
Matte finish (standard)
Finition mate (standard)



Finitura lucida (opzionale)
Glossy finish (optional)
Finition brillante (sur demande)



Finit. goffrato fine (opzionale)
Finish embossed (optional)
Terminer en relief (sur demande)

Verificare su mazzetta i colori reali, quelli riportati sul presente catalogo sono puramente indicativi
Check wad of real colors, as shown in this catalog are purely indicative
Vérifiez liasse de couleurs réelles, comme indiqué dans ce catalogue sont purement indicatives



Delicata armonia

Delicata armonia

Il design elegante e raffinato incontra la tecnologia. La struttura in legno listellare dell'imbotte e l'anta tamburata conferiscono alla linea BUTTERFLY elevate prestazioni costruttive che insieme al design delle incisioni e alla texture delle laccature fanno di questa linea un oggetto prezioso e funzionale.

Delicate harmony

The sleek and elegant design meets technology. The structure made of wood strips intrados and the paneled door lend the line BUTTERFLY high performance building that together with the design of the incisions and the texture of the lacquer make this line a precious and functional.

Délicate harmonie

Le design épuré et élégant rencontre la technologie. La structure faite de bandes de bois intrados et la porte lambrissée prêtent le BUTTERFLY bâtiment de haute performance de la ligne qui, avec la conception des incisions et la texture de la laque faire cette ligne un précieux et fonctionnel.

Interni Coordinati

Armonia ed eleganza sono alla base del concetto proposto da OTC DOORS per coordinare la porta blindata con il resto delle porte interne, grazie alla possibilità di avere il pannello interno, porte tuttovetro, coprifili e battiscopa delle stesse finiture della collezione BUTTERFLY.

Harmony and elegance are the basis of the concept proposed by OTC DOORS to coordinate the security door with the rest of the internal doors, thanks to the possibility of having the internal panel, all glass doors, backlining and skirting of the same finishes as the BUTTERFLY collection.

L'harmonie et l'élégance sont à la base du concept proposé par OTC DOORS pour coordonner la porte blindée avec le reste des portes intérieures, grâce à la possibilité d'avoir le panneau intérieur, portes tout en verre, cache-fils et plinthe des mêmes finitions que la collection BUTTERFLY.

Porta blindata NEREA
Security door NEREA
Porte de sécurité NEREA

Rivestimento interno V08 Laccato RAL 9001
Internal panel V08 Lacquered RAL 9001
Panneaux intérieur V08 Laqué RAL 9001

V08 Laccato RAL9001
Lacquered RAL 9001
Laqué RAL 9001



V05 Laccato RAL 7038, imbotte Raggio 2 con cerniere a scomparsa
Lacquered RAL 7038, blockboard Radius 2 with invisible hinges
Laqué RAL 7038, bâti Rayon 2 avec charnières invisibles



V03 Laccato lucido RAL 7012, imbotte Raggio 2
Glossy RAL 7012, Radius 2 blockboard
Laqué brillant RAL 7012, bâti Rayon 2

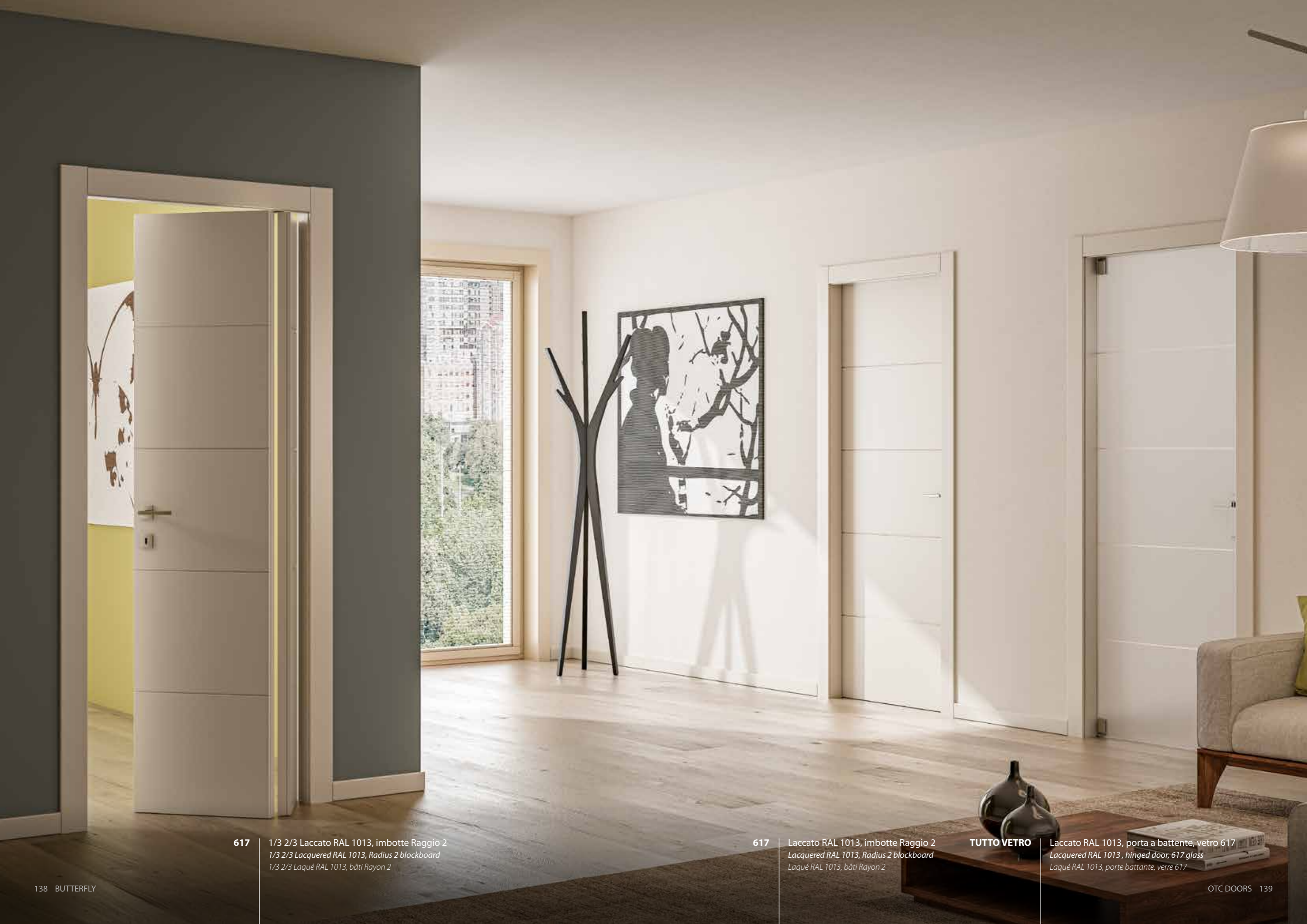

617 1/3 2/3 Laccato RAL 1013, imbotte Raggio 2
1/3 2/3 Lacquered RAL 1013, Radius 2 blockboard
1/3 2/3 Laqué RAL 1013, bâti Rayon 2

617 Laccato RAL 1013, imbotte Raggio 2
Lacquered RAL 1013, Radius 2 blockboard
Laqué RAL 1013, bâti Rayon 2

TUTTO VETRO Laccato RAL 1013, porta a battente, vetro 617
Lacquered RAL 1013, hinged door, 617 glass
Laqué RAL 1013, porte battante, verre 617

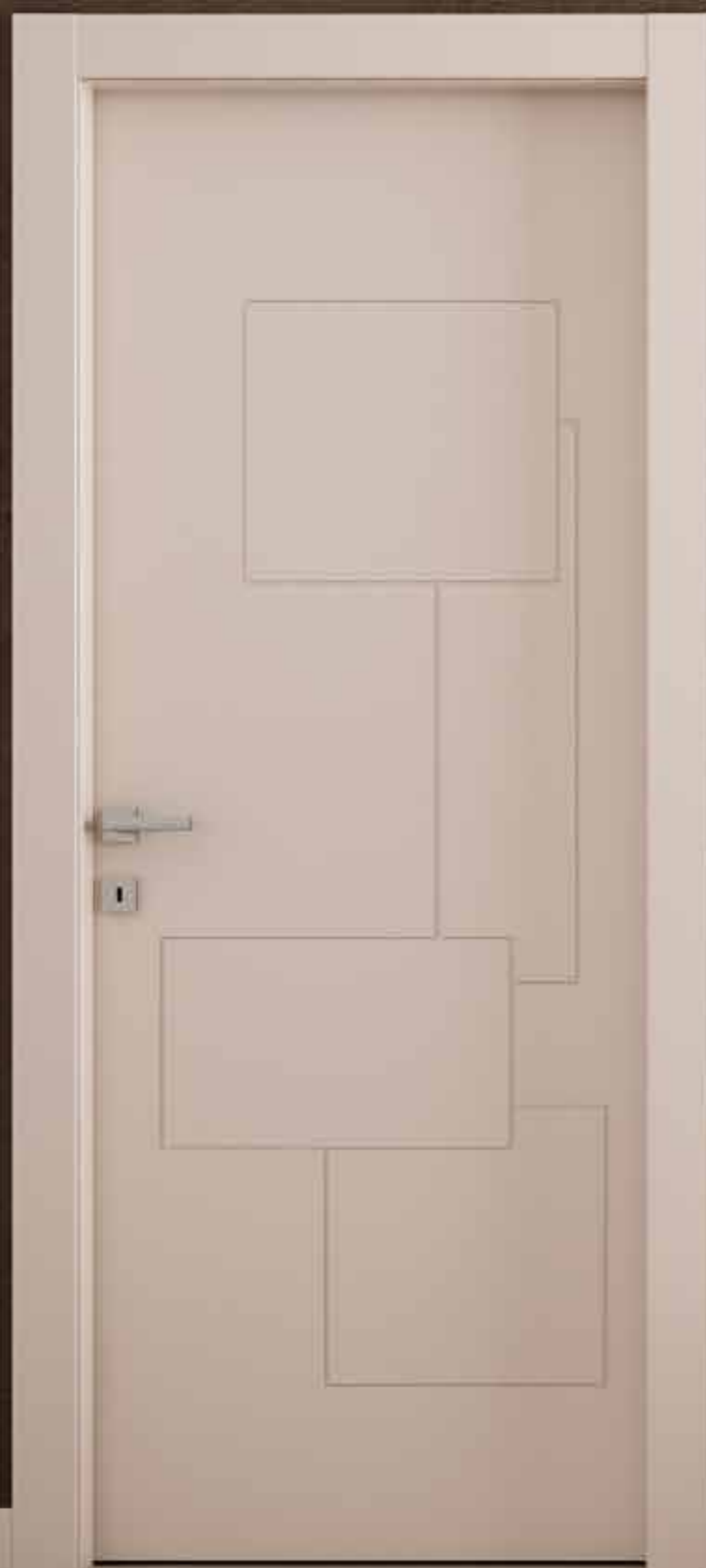

N01 | Laccato RAL 9001, imbottite Raggio 2
Lacquered RAL 9001, Radius 2 blockboard
Laqué RAL 9001, bâti Rayon 2



TUTTO VETRO | Laccato RAL 9001, scorrevole a scomparsa, vetro N01
Lacquered RAL 9001, fully-retracting sliding door, N01 glass
Laqué RAL 9001, porte coulissante escamotable, verre N01



N04 Laccato RAL 9002, imbotte Raggio 2
Lacquered RAL 9002, Radius 2 blockboard
Laqué RAL 9002, bâti Rayon 2

TUTTO VETRO Laccato RAL 9002, porta a battente, Vetro N04
Lacquered RAL 9002, hinged door, N04 glass
Laqué RAL 9002, porte battante, verre N04



N09 Laccato RAL 9010, imbotte Raggio 2
Lacquered RAL 9010, Radius 2 blockboard
Laqué RAL 9010, bâti Rayon 2

TUTTO VETRO Laccato RAL 9010, porta a battente, Vetro N09
Lacquered RAL 9010, hinged door, N09 glass
Laqué RAL 9010, porte battante, verre N09



N02 Laccato RAL 9001, Imbotte Raggio 2
Lacquered RAL 9001, Radius 2 blockboard
Laqué RAL 9001, bâti Rayon 2



TUTTO VETRO

Scorrevole esterno, Vetro N02, guida Small
Exposed sliding door, N02 glass, sliding rail Small
Porte coulissante externe paroi, Verre N02, rail de guidage Small



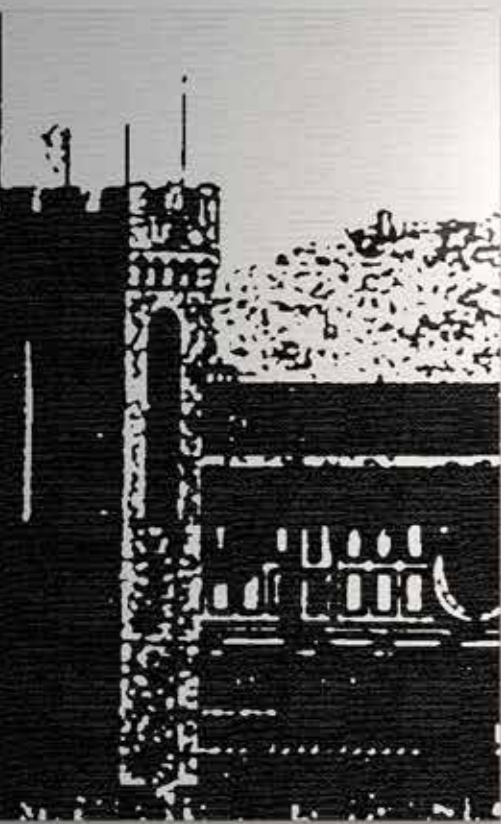

680 Filo imbotte, Laccato RAL 1013
 Blockboard coplanar, Lacquered RAL 1013
 Bâti coplanaires, Laqué RAL 1013

Laccato colori
 standard
 Lacquered
 standard colors
 Couleurs
 standard laqués

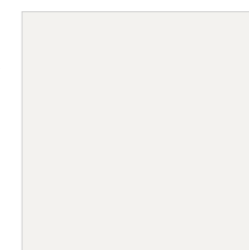

RAL 9003

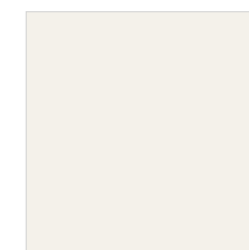

RAL 9010



RAL 9001



RAL 1013

RAL (opzionale)
 RAL (optional)
 RAL (sur demande)

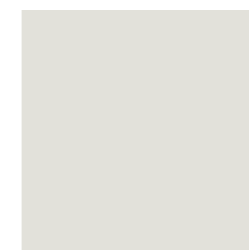

RAL 9002



RAL 9018



RAL 7038



RAL 7024



RAL 7032



RAL 7035



RAL 7046



RAL 8019



RAL 7044



RAL 7036



RAL 7012



RAL 9011



RAL 3012



RAL 3011



RAL 6019



RAL 5001



Altri colori RAL su richiesta
 Other RAL colors on request
 Autres couleurs RAL sur demande



Finitura opaca (di serie)
 Matte finish (standard)
 Finition mate (standard)



Finitura lucida (opzionale)
 Glossy finish (optional)
 Finition brillante (sur demande)

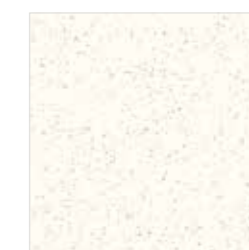

Finit. goffrato fine (opzionale)
 Finish embossed (optional)
 Terminer en relief (sur demande)

Verificare su mazzetta i colori reali, quelli riportati sul presente catalogo sono puramente indicativi
 Check wad of real colors, as shown in this catalog are purely indicative
 Vérifiez liasse de couleurs réelles, comme indiqué dans ce catalogue sont purement indicatives

Modelli
Models
Modèles



6x2 mm

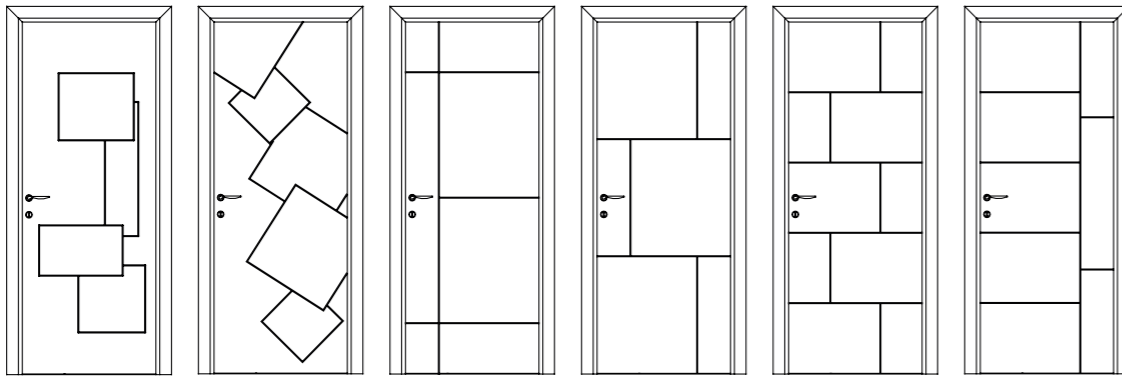
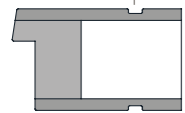

N01

N02

N03

N04

N05

N06

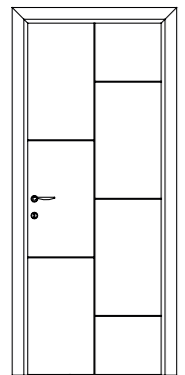

N07

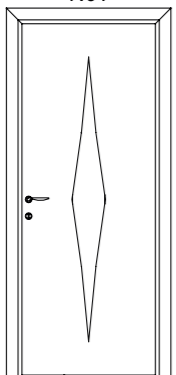

N08

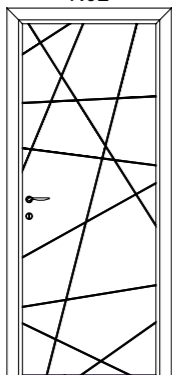

N09

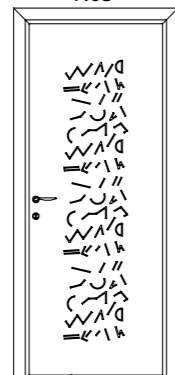

N10

Per lavorazioni personalizzate, contattare l'ufficio commerciale.
For working on the request to contact the sales office.
Pour travailler sur la demande de contacter le bureau des ventes.

Modelli
Models
Modèles

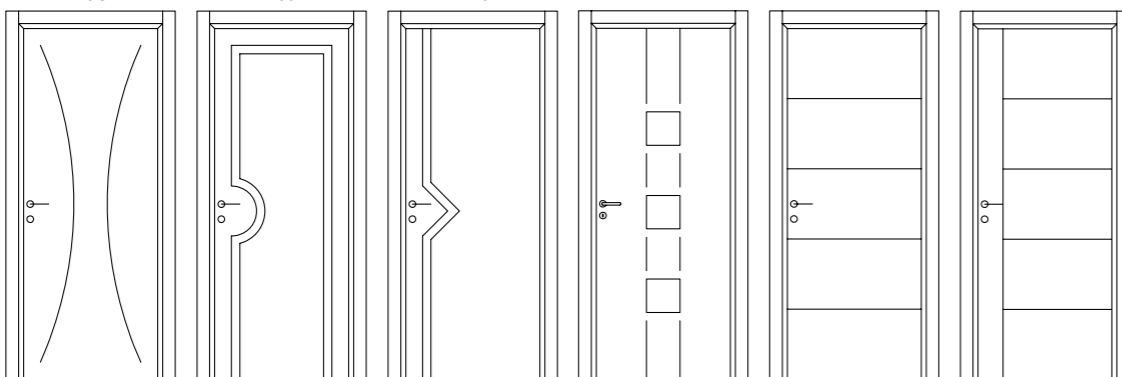

601

606

609

615

617

618

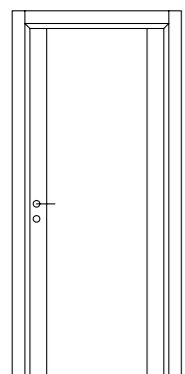

620

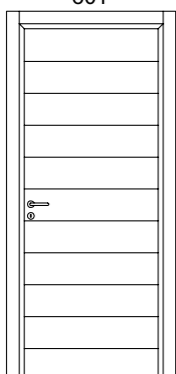

628

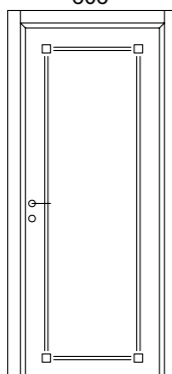

641

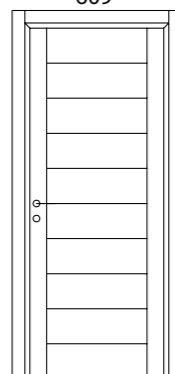

655

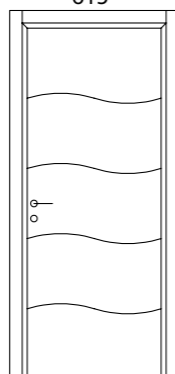

657

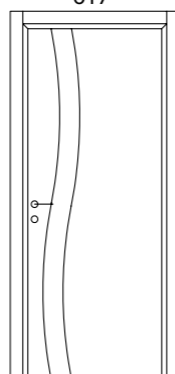

659

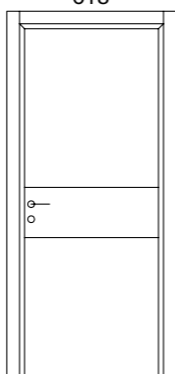

663

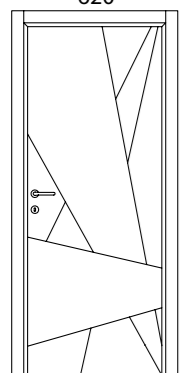

680

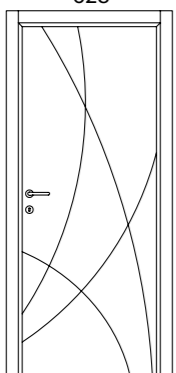

681

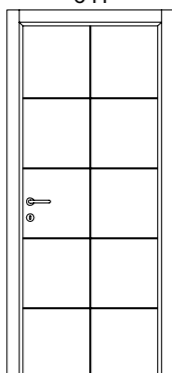

686

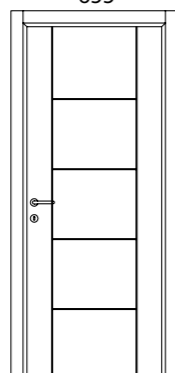

687

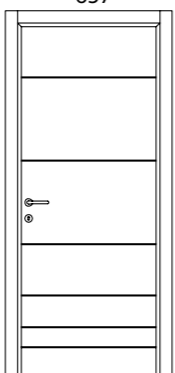

691

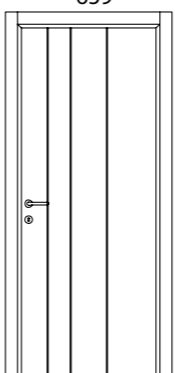

693

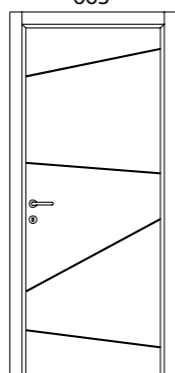

695

Modelli "V"
Models "V"
Modèles "V"

8x4 mm

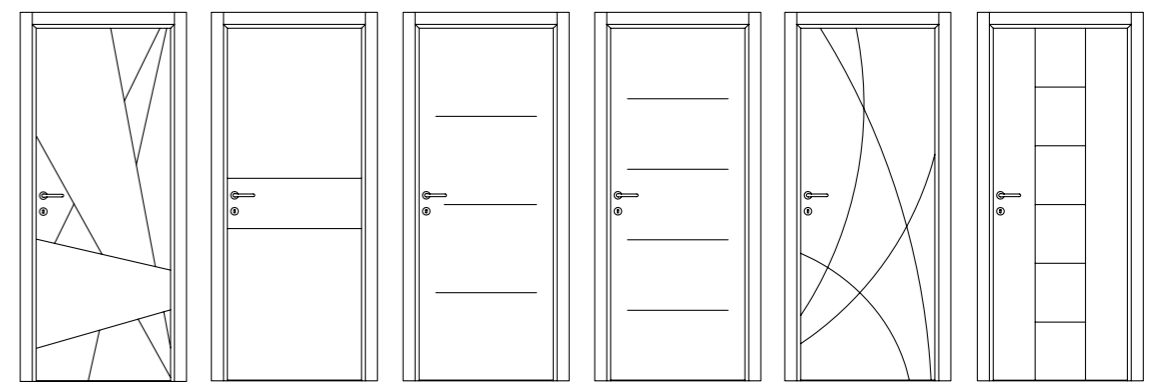

V01

V02

V03

V04

V05

V06

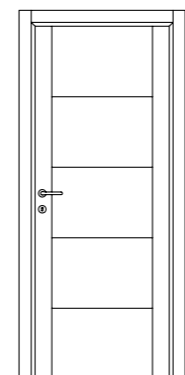

V07

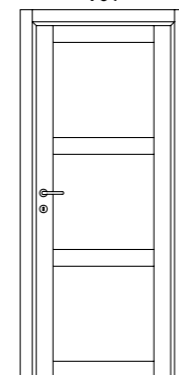

V08

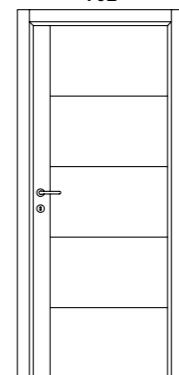

V09

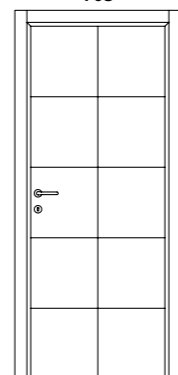

V10

Per lavorazioni personalizzate, contattare l'ufficio commerciale.
For working on the request to contact the sales office.
Pour travailler sur la demande de contacter le bureau des ventes.

Imbotte - Raggio 10 con cerniera anuba (Standard)*
Door jamb - Radius 10 with anuba hinge (Standard)*
Intrados - Rayon 10 avec charnière anuba (Standard)*

Coprifilo telescopico in legno multistrato 70 mm
Multi-layer telescopic wood backlining 70 mm
Cache-fils télescopique en bois multicouche 70 mm

Imbotte in legno listellare
Blockboard door jamb
Intrados en bois lamellé

Raggio 10 mm
Radius 10 mm
Rayon 10 mm

Incisione 6x2 mm
Engraving 6x2 mm
Gravure 6x2 mm

Incisione 8x4 mm
Engraving 8x4 mm
Gravure 8x4 mm

Scopri gli imbotti opzionali disponibili a pag. 196
Discover the other optional upholstery available on p. 196
Découvrez les autres selleries optionnelles disponibles p. 196





Classica eleganza

Classica eleganza

Le modanature di TURANDOT rievocano un gusto classico sobrio in grado di arricchire sia gli ambienti in stile che quelli più contemporanei. La struttura con imbotte completamente listellare, l'anta tamburata pantografata ad angolo con precisione assoluta, la laccatura di alta qualità: l'anima tecnologica di una porta straordinariamente bella.

Classic elegance

Moldings evoke a classic taste sober can enrich both stylish environments that more contemporary ones. The soffit structure with fully laminated, the hollow-core door pantografata corner with absolute precision, the lacquer of high quality: the technological core of a door extraordinarily beautiful.

Élégance classique

Moultures évoquent un décor sobre de goût classique peut enrichir les environnements élégants que de ceux plus contemporains. La structure de la sous-face avec totalement laminé, le coin à âme creuse porte pantografata avec une précision absolue, la laque de haute qualité: le noyau technologique d'une porte extraordinairement belle.



727 Laccato RAL 1013
Lacquered RAL 1013
Laqué RAL 1013

727 Scorrevole a scomparsa, Laccato RAL 1013
Retractable sliding, Lacquered RAL 1013
Coulissante à galandage, Laqué RAL 1013



701 Laccato RAL 9001, imbotte Raggio 2
Lacquered RAL 9001, Radius 2 blockboard
Laqué RAL 9001, bâti Rayon 2

703 Laccato RAL 9001, imbotte Raggio 2, vetro molato satinato bianco
Lacquered RAL 9001, Radius 2, satin-finish cut glass
Laqué RAL 9001, Rayon 2, verre moulé satiné blanc



734 Laccato RAL 3012, vetro satinato bianco Flora
Lacquered RAL 3012, Flora satin-finish glass
Laqué RAL 3012, verre satiné blanc Flora

733 Laccato RAL 3012
Lacquered RAL 3012
Laqué RAL 3012



704 | Laccato RAL 9001, Imbotte Raggio 2
Lacquered RAL 9001, Radius 2 blockboard
Laqué RAL 9001, Bâti Rayon 2

705 | Laccato RAL 9001, imbotte Raggio 2, vetro satinato bianco Ibiscus
Lacquered RAL 9001, Radius 2 Blockboard, Ibiscus satin-finish glass
Laqué RAL 9001, Bâti Rayon 2, verre satiné blanc Ibiscus



759 | Laccato RAL 7038
Lacquered RAL 7038
Laqué RAL 7038

757 | Laccato RAL 7038, vetro satinato bianco Lotus
Lacquered RAL 7038, Lotus white satin-finish glass
Laqué RAL 7038, verre satiné blanc Lotus



701 Laccato RAL 9003
Lacquered RAL 9003
Laqué RAL 9003



702 Scorrevole esterno parete, Laccato RAL 9003, vetro Nest
Exposed sliding, Lacquered RAL 9003, Nest glass
Coulissante externe paroi, Laqué RAL 9003, verre Nest



720 | Laccato RAL 7036
Lacquered RAL 7036
Laqué RAL 7036



- 742** | Laccato RAL 9003
Lacquered RAL 9003
Laqué RAL 9003
- 743** | Scorrevole a scomparsa RAL 9003, vetro satinato bianco Lotus
Retractable sliding, Lacquered RAL 9003, Lotus white satin-finish glass
Coulissante à galandage, Laqué RAL 9003, verre satiné blanc Lotus



727 Decò P3 Portale Venezia
Decò P3 Portale Venezia
Decò P3 Portale Venezia



730 Decò p4

712 Decò p3



Modelli
Models
Modèles

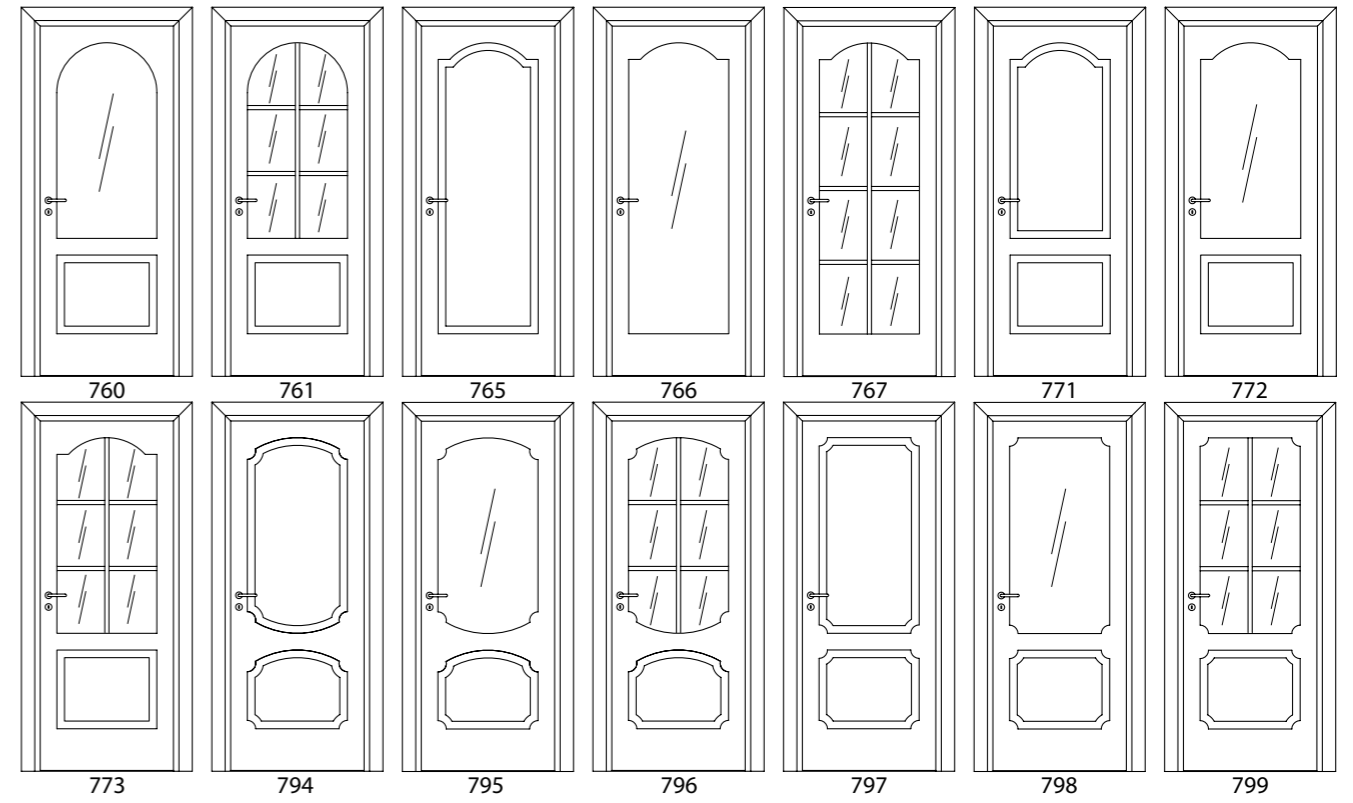
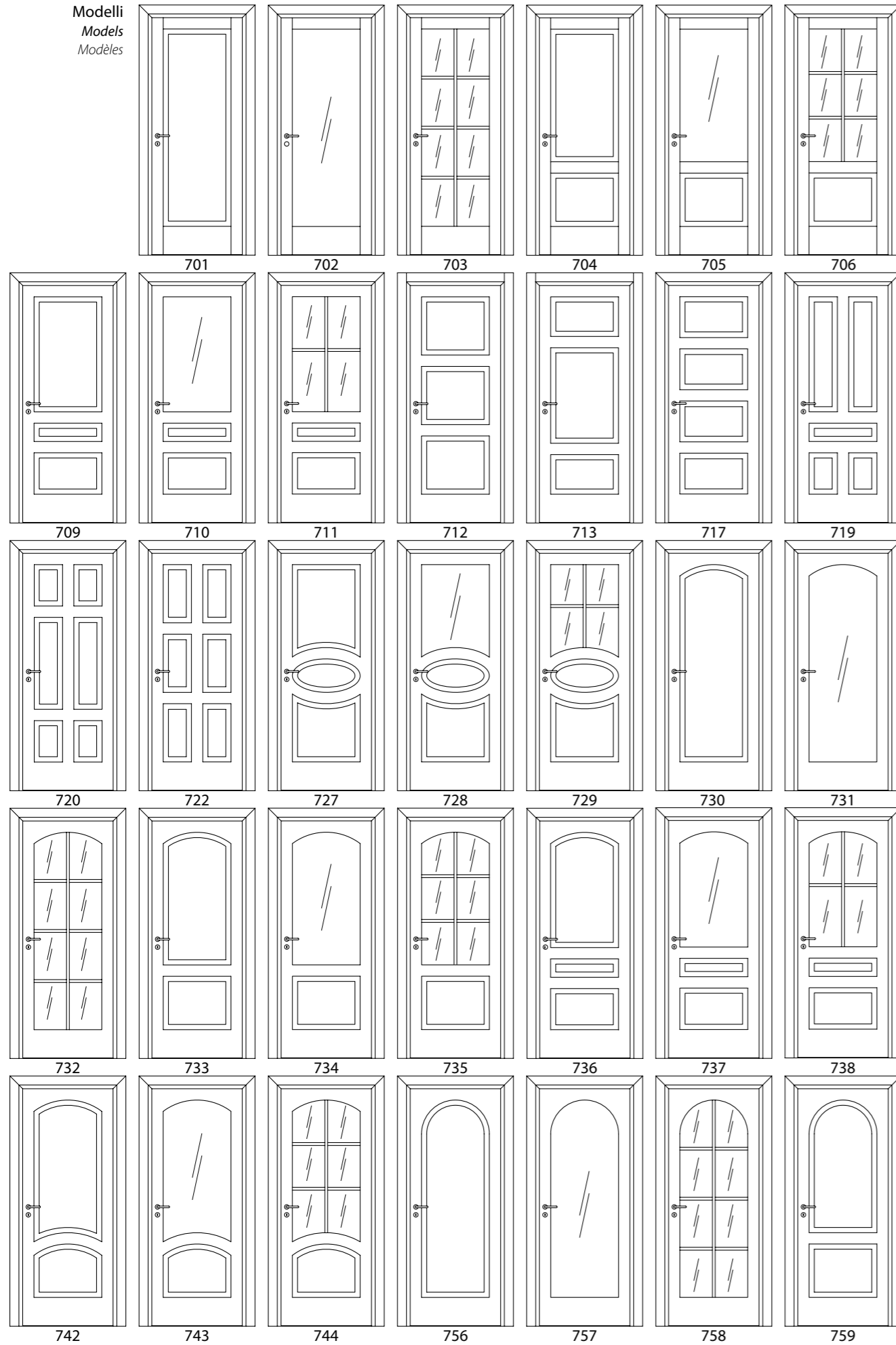

Per lavorazioni e disegni personalizzati, si prega di contattare l'ufficio commerciale.
Bespoke designs may be produced to meet special aesthetic requirements
Pour des exigences esthétiques particulières, il est possible de réaliser des dessins personnalisés

Imbotte - Raggio 10 con cerniera anuba (Standard)*
Door jamb - Radius 10 with anuba hinge (Standard)*
Intrados - Rayon 10 avec charnière anuba (Standard)*

Scopri gli imbotti opzionali disponibili a pag. 196
Discover the other optional upholstery available on p. 196
Découvrez les autres selleries optionnelles disponibles p. 196

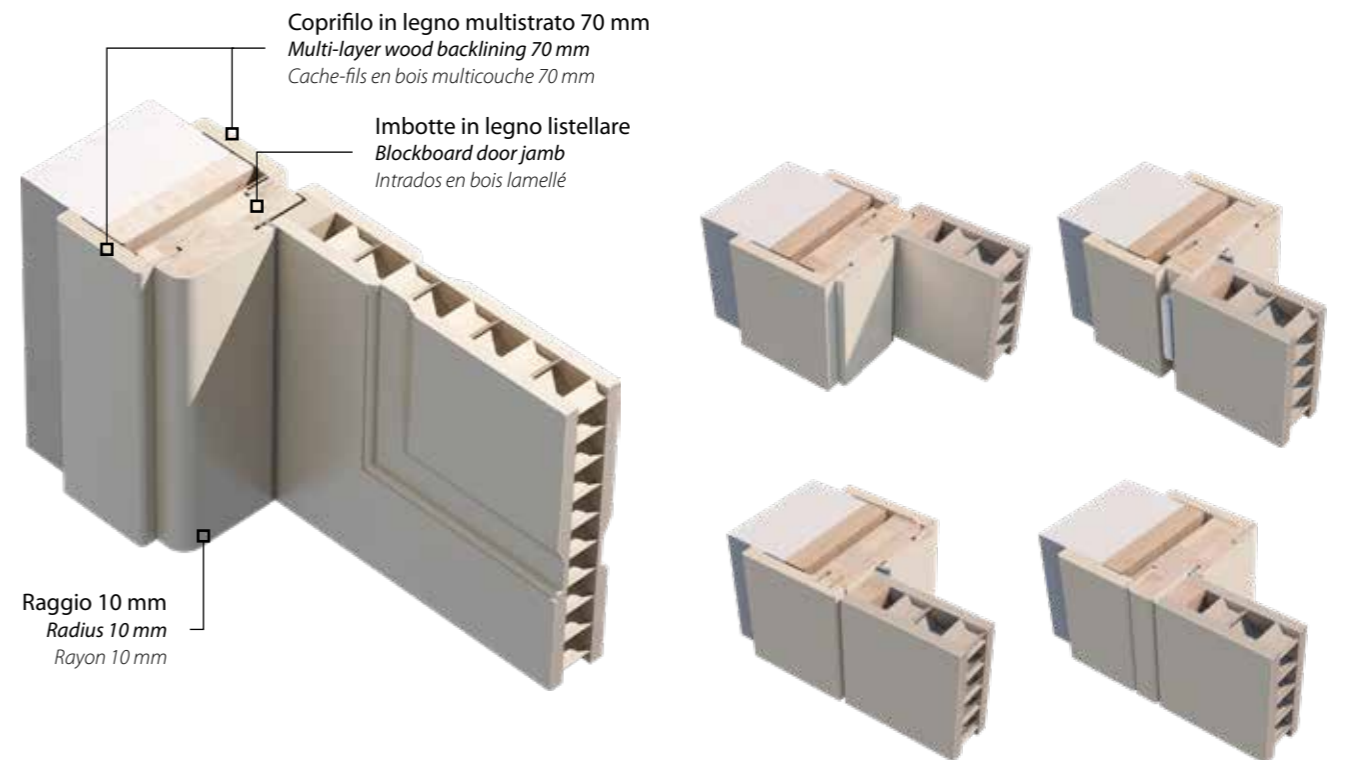

Laccato colori standard
Lacquered standard colors
Couleurs standard laqués

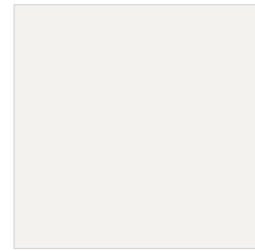

RAL 9003



RAL 9010

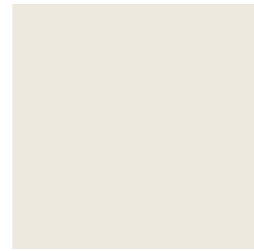

RAL 9001

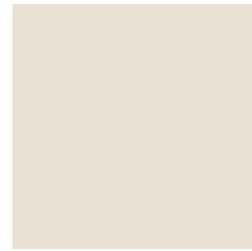

RAL 1013

RAL (opzionale)
RAL (optional)
RAL (sur demande)

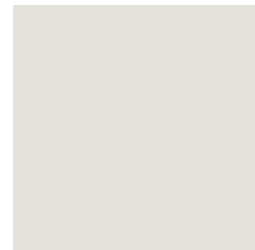

RAL 9002

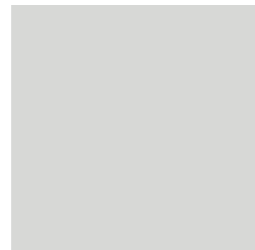

RAL 9018



RAL 7038



RAL 7024

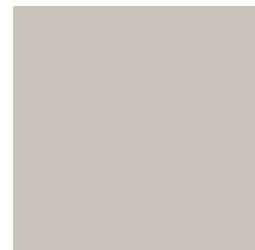

RAL 7032

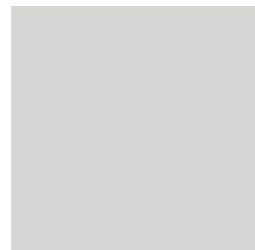

RAL 7035



RAL 7046



RAL 8019

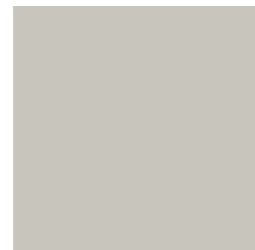

RAL 7044



RAL 7036



RAL 7012



RAL 9011



RAL 3012



RAL 3011



RAL 6019



RAL 5001



Altri colori RAL su richiesta
Other RAL colors on request
Autres couleurs RAL sur demande

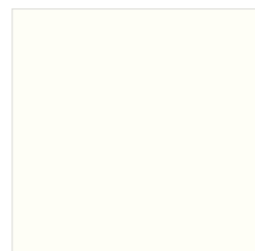

Finitura opaca (di serie)
Matte finish (standard)
Finition mate (standard)



Finitura lucida (opzionale)
Glossy finish (optional)
Finition brillante (sur demande)

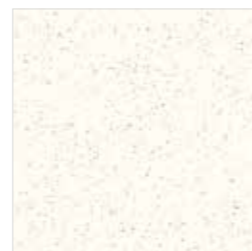

Finit. goffrato fine (opzionale)
Finish embossed (optional)
Terminer en relief (sur demande)

Verificare su mazzetta i colori reali, quelli riportati sul presente catalogo sono puramente indicativi
Check wad of real colors, as shown in this catalog are purely indicative
Vérifiez liasse de couleurs réelles, comme indiqué dans ce catalogue sont purement indicatives

Decò - Finiture eseguite a mano
Decò - Hand-made finishes
Decò - Finitions à la main



p1



p2



p3



p4



p5



p6



Decò
Decorata a mano. Le porte Decò di OTC DOORS, grazie alle mani sapienti di abili artigiani, valorizzano gli ambienti più importanti.

Hand decorated. The result of the skilful hands of expert craftsmen, OTC DOORS' Decò doors add value to the most important spaces.

Décorée à la main. Les portes Decò d'OTC DOORS, grâce aux mains expertes d'artisans habiles, valorisent les intérieurs les plus importants.



Opere che arredano

Opere che arredano

Pensata per chi cerca una porta elegante per arredare i propri ambienti con il sapore unico del legno e la garanzia di un sistema strutturale tecnologicamente avanzato. Le elevate prestazioni costruttive conferite dalla struttura in legno listellare dell'imbotte e dall'anta tamburata rivestita in essenza, rendono le porte della collezione OTELLO affidabili, con un alto valore estetico, funzionale e di durabilità nel tempo.

Works of art

Designed for those seeking a stylish door to furnish your environments with the unique flavor of the wood, and the guarantee of a structural system technologically advanced. The high performance construction conferred by the structure made of wood strips and intrados by leaf hollow covered in essence, make the doors of the collection OTELLO reliable, with a high aesthetic, functional and durability.

Des créations qui habillent

Conçu pour ceux qui cherchent une porte de style de fournir vos environnements avec la saveur unique du bois, et la garantie d'un système structurel avancés technologiquement. La construction de haute performance conféré par la structure faite de bandes de bois et intrados par feuille creuse couverte en substance, faire les portes de la collection OTELLO fiable, avec une grande durabilité et esthétique, fonctionnelle.



288 | Rovere Tinto Miele, imbotte Raggio 2
Oak Dyed Honey, Radius 2 blockboard
Chêne Teinté Miel, bâti Rayon 2



290 | Rovere Tabacco, imbotte Raggio 2
Oak Tobacco, Radius 2 blockboard
Chêne Tabac, bâti Rayon 2

Interni Coordinati

Armonia ed eleganza sono alla base del concetto proposto da OTC DOORS per coordinare la porta blindata con il resto delle porte interne, grazie alla possibilità di avere il pannello interno, porte tuttovetro, coprifili e battiscopa delle stesse finiture della collezione OTELLO.

Harmony and elegance are the basis of the concept proposed by OTC DOORS to coordinate the security door with the rest of the internal doors, thanks to the possibility of having the internal panel, all glass doors, backlining and skirting of the same finishes as the OTELLO collection.

L'harmonie et l'élégance sont à la base du concept proposé par OTC DOORS pour coordonner la porte blindée avec le reste des portes intérieures, grâce à la possibilité d'avoir le panneau intérieur, portes tout en verre, cache-fils et plinthe des mêmes finitions que la collection OTELLO.



Porta blindata NEREA
Security door NEREA
Porte de sécurité NEREA

Rivestimento interno Laccato RAL 9003
Internal panel Lacquered RAL 9003
Panneaux intérieurs Laqué RAL 9003

251

Laccato RAL 9003, imbotta Raggio 2 con cerniera a scomparsa
Lacquered RAL 9003, blockboard door Radius 2 with invisible hinges
Laqué RAL 9003, bâti Rayon 2 avec charnières invisibles

251

Filo imbotta, Laccato RAL 9003
Blockboard coplanar, Lacquered RAL 9003
Bâti coplanaires, Laqué RAL 9003



286 inciso
graven
gravé

Castagno Laccato a Poro Aperto RAL 9001, imbotte Raggio 2
Open Pore Lacquered RAL 9001, Radius 2 blockboard
Châtaigne Laqué Pore ouvert RAL 9001, bâti Rayon 2



280 | Castagno Tinto Medio
Chestnut Dyed Medium
Châtaigne Teinté Moyenne

Interni Coordinati

Armonia ed eleganza sono alla base del concetto proposto da OTC DOORS per coordinare la porta blindata con il resto delle porte interne, grazie alla possibilità di avere il pannello interno, porte tuttovetro, coprifili e battiscopa delle stesse finiture della collezione OTELLO.

Harmony and elegance are the basis of the concept proposed by OTC DOORS to coordinate the security door with the rest of the internal doors, thanks to the possibility of having the internal panel, all glass doors, backlining and skirting of the same finishes as the OTELLO collection.

L'harmonie et l'élégance sont à la base du concept proposé par OTC DOORS pour coordonner la porte blindée avec le reste des portes intérieures, grâce à la possibilité d'avoir le panneau intérieur, portes tout en verre, cache-fils et plinthe des mêmes finitions que la collection OTELLO.



278 Noce Nazionale Tinto Medio
Italian Walnut Dyed Medium
Panneaux intérieurs 278 Italian Walnut Dyed Medium

TUTTO VETRO Noce Nazionale Tinto Medio, porta a battente, vetro Iris carta
Italian Walnut Dyed Medium, hinged door, Iris carta glass
Italian Walnut Dyed Medium, porte battante, verre Iris carta

Porta blindata ELIDE
Security door ELIDE
Porte de sécurité ELIDE

Rivestimento interno 278 Noce Nazionale Tinto Medio
Internal panel 278 Italian Walnut Dyed Medium
Panneaux intérieurs 278 Italian Walnut Dyed Medium



251 | Laccato RAL 9003, imbotte Raggio 2
 Laquered RAL 9003, Radius 2 blockboard
 Laqué RAL 9003, bâti Rayon 2

252 | Laccato RAL 9003, vetro Mondrian, imbotte Raggio 2
 Laquered RAL 9003, Mondrian glass, Radius 2 blockboard
 Laqué RAL 9003, verre Mondrian, bâti Rayon 2



287 inciso | Castagno Laccato a Poro aperto RAL 9005, imbotte Raggio 2
 graven | Open Pore Lacquered RAL 9005 Chestnut, Radius 2 blockboard
 gravé | Châtaigne Laqué Pore ouvert RAL 9005, bâti Rayon 2

Modelli e filetti
Models and stripes
Modèles et bandes

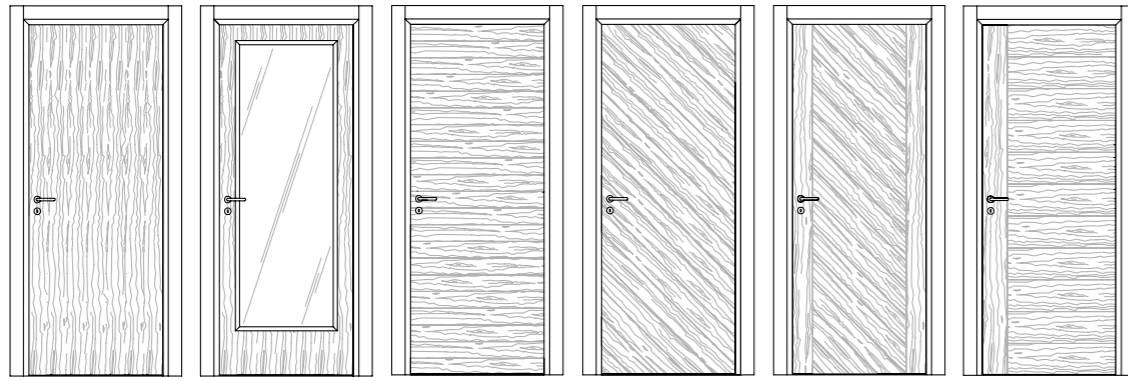

251

252

278

279

280

283

Incisione 6x2 mm
Engraving 6x2 mm
Gravure 6x2 mm

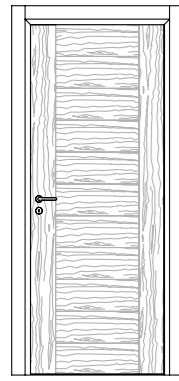
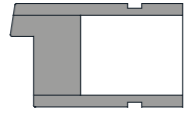

284

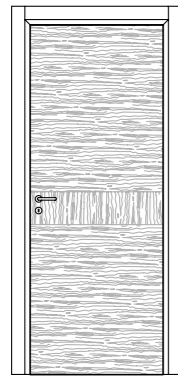

288

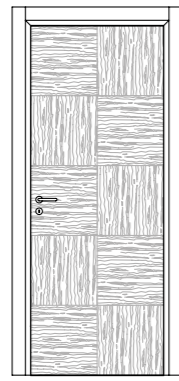

290

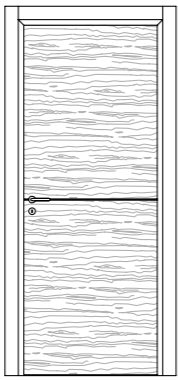

285 inciso

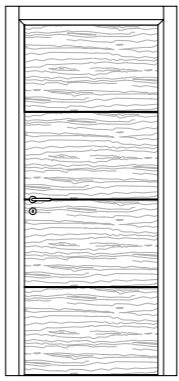

286 inciso

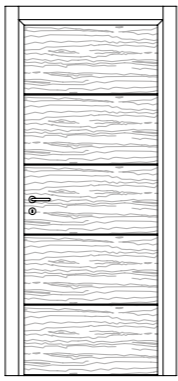

287 inciso

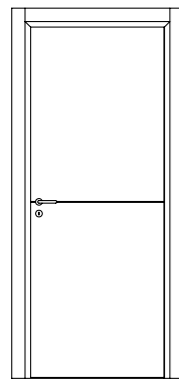

1FM

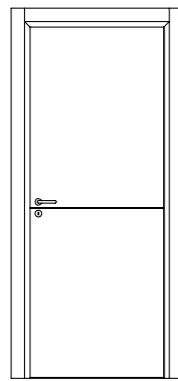

1F

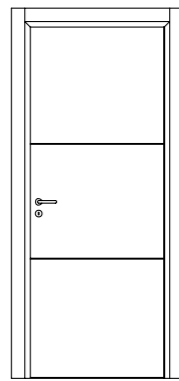

2FE

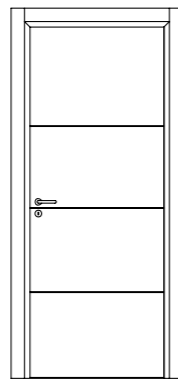

3FE

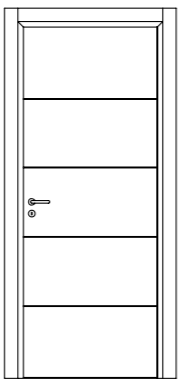

4FE

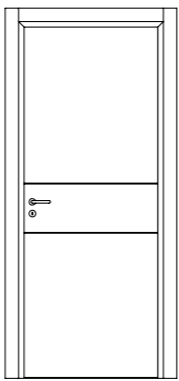

2FG

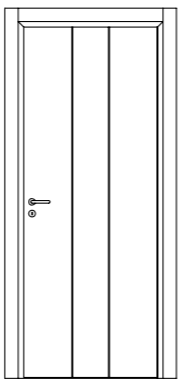

2FV

Imbotte - Raggio 10 con cerniera anuba (Standard)*
Door jamb - Radius 10 with anuba hinge (Standard)*
Intrados - Rayon 10 avec charnière anuba (Standard)*

Scopri gli imbotti opzionali disponibili a pag. 196
Discover the other optional upholstery available on p. 196
Découvrez les autres selleries optionnelles disponibles p. 196

Coprifilo telescopico in legno multistrato 70 mm
Multi-layer telescopic wood backlining 70 mm
Cache-fils télescopique en bois multicouche 70 mm

Imbotte in legno listellare
Blockboard door jamb
Intrados en bois lamellé

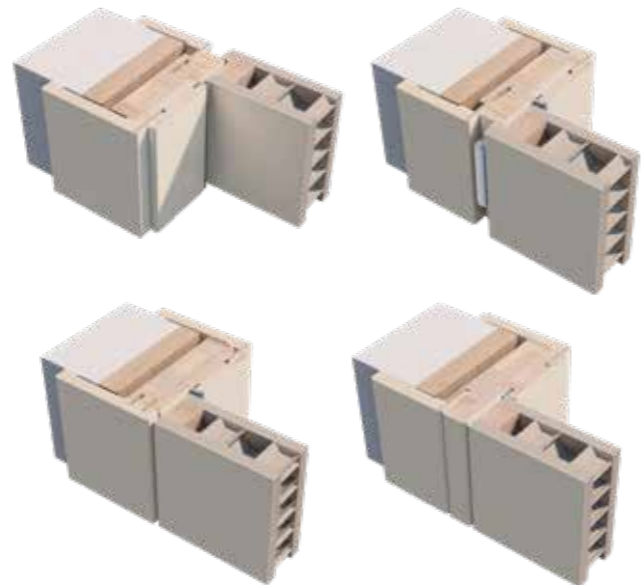

Raggio 10 mm
Radius 10 mm
Rayon 10 mm

Finiture e laccature standard
Standard finishes and lacquer
Finitions et vernis en standard



Tanganica Tinto Ciliegio
Tanganika Dyed Cherry
Tanganika Teinté Cerise



Tanganica Tinto Medio
Tanganika Dyed Medium
Tanganika Teinté Moyenne



Rovere Naturale
Natural Oak
Chêne Naturel



Rovere Tinto Miele
Oak Dyed Honey
Chêne Teinté Miel



Rovere Tabacco
Oak Tobacco
Chêne Tabac



Castagno Tinto Medio
Chestnut Dyed Medium
Châtaigne Teinté Moyenne



Noce Nazionale Tinto Medio
Italian Walnut Dyed Medium
Noyer Italien Teinté Moyenne



Castagno Laccato a Poro aperto RAL
Open Pore Lacquered RAL Chestnut
Châtaigne Laqué Pore ouvert RAL



Castagno Decò L2
Decò L2 Chestnut
Châtaigne Decò L2



Castagno Decò L1
Decò L1 Chestnut
Châtaigne Decò L1



Castagno Laccato a Poro aperto RAL 9005
Open Pore Lacquered RAL Chestnut 9005
Châtaigne Laqué Pore ouvert RAL 9005

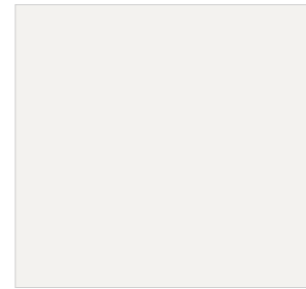

Laccato RAL 9003
Laquered RAL 9003
Laqué RAL 9003

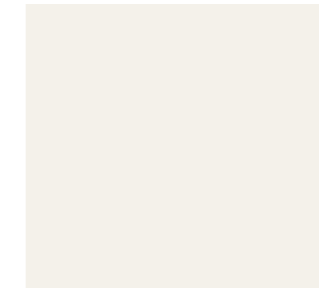

Laccato RAL 9010
Laquered RAL 9010
Laqué RAL 9010

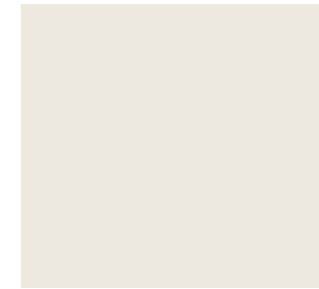

Laccato RAL 9001
Laquered RAL 9001
Laqué RAL 9001

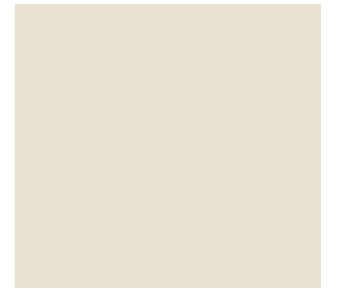

Laccato RAL 1013
Laquered RAL 1013
Laqué RAL 1013



Altri colori RAL su richiesta / Other RAL colors on request / Autres couleurs RAL sur demande

Verificare su mazzetta i colori reali, quelli riportati sul presente catalogo sono puramente indicativi
Check wad of real colors, as shown in this catalog are purely indicative
Vérifiez liasse de couleurs réelles, comme indiqué dans ce catalogue sont purement indicatives



Stile senza tempo

Stile senza tempo

Le porte GRANDUCATO esprimono il sapore dell'artigianato toscano del legno, sapientemente lavorato con tecnologie moderne. I raffinati particolari in massello e la struttura perimetrale dell'anta e dell'imbotte interamente in legno listellare, conferiscono alla porta Granducato un valore destinato a durare nel tempo.

Timeless style

The doors GRANDUCATO express the flavor of Tuscan wood, skillfully worked with modern technology. The fine details in solid and the structure of the leaf and perimeter intrados entirely of wood strips, giving the Grand Duchy brings a value that will last over time.

Style intemporel

Les portes GRANDUCATO expriment la saveur de bois toscane, habilement travaillé avec la technologie moderne. Les détails fins à l'état solide et la structure de la feuille et le périmètre intrados entièrement de bandes de bois, donnant le Grand-Duché apporte une valeur qui va durer dans le temps.

Interni Coordinati

Armonia ed eleganza sono alla base del concetto proposto da OTC DOORS per coordinare la porta blindata con il resto delle porte interne, grazie alla possibilità di avere il pannello interno, porte tuttovetro, coprifili e battiscopa delle stesse finiture della collezione GRANDUCATO.

Harmony and elegance are the basis of the concept proposed by OTC DOORS to coordinate the security door with the rest of the internal doors, thanks to the possibility of having the internal panel, all glass doors, backlining and skirting of the same finishes as the GRANDUCATO collection.

L'harmonie et l'élégance sont à la base du concept proposé par OTC DOORS pour coordonner la porte blindée avec le reste des portes intérieures, grâce à la possibilité d'avoir le panneau intérieur, portes tout en verre, cache-fils et plinthe des mêmes finitions que la collection GRANDUCATO.



574 Castagno Decò L2
Chestnut Decò L2
Châtaigne Decò L2

576 Castagno Decò L2, vetro molato satinato bianco
Chestnut Decò L2, satin-finish cut glass
Châtaigne Decò L2, verre moulé satiné blanc

Porta blindata NEREA
Security door NEREA
Porte de sécurité NEREA

Rivestimento interno 574 Castagno Decò L2
Internal panel 574 Decò L2 Chestnut
Panneaux intérieur 574 Châtaigne Decò L2



574 Castagno Tinto Medio
Chestnut Dyed Medium
Châtaigne Teinté Moyenne

575 Castagno Tinto Medio, vetro satinato bianco Lotus
Chestnut Dyed Medium, Lotus white satin-finish glass
Châtaigne Teinté Moyenne, verre satiné blanc Lotus



572 Noce Nazionale Tinto Medio, vetro satinato bianco
Italian Walnut Dyed Medium, white satin-finish glass
Noyer Italien Teinté Moyenne, verre satiné blanc

574 Noce Nazionale Tinto Medio
Italian Walnut Dyed Medium
Noyer Italien Teinté Moyenne

574 Portale Impero Laccato RAL 1013
Portale Impero Laquered RAL 1013
Portale Impero Laqué RAL 1013





578 Rototraslante Noce Nazionale Tinto Medio, vetro satinato bianco
Rototranslating Italian Walnut Dyed Medium, white satin-finish glass
Pivotante Noyer Italien Teinté Moyenne, verre satiné blanc

577 Noce Nazionale Tinto Medio
Italian Walnut Dyed Medium
Noyer Italien Teinté Moyenne



574 Castagno Laccato a Poro aperto RAL 9001
Open Pore Lacquered RAL 9001 Chestnut
Châtaigne Laqué Pore ouvert RAL 9001



591 | Castagno Decò L1
Decò L1 Chestnut
Châtaigne Decò L1



- 580** | Scorrevole a scomparsa, Noce Nazionale Tinto Medio
Retractable sliding Italian Walnut Dyed Medium
Coulissante à galandage Noyer Italien Teinté Moyenne
- 582** | Noce Nazionale Tinto Medio, vetro molato satinato bianco
Italian Walnut Dyed Medium, white satin-finish cut glass
Noyer Italien Teinté Moyenne, verre moulé satiné blanc
- 571** | Castagno Tinto Medio
Chestnut Dyed Medium
Châtaigne Teinté Moyenne



Modelli
Models
Modèles

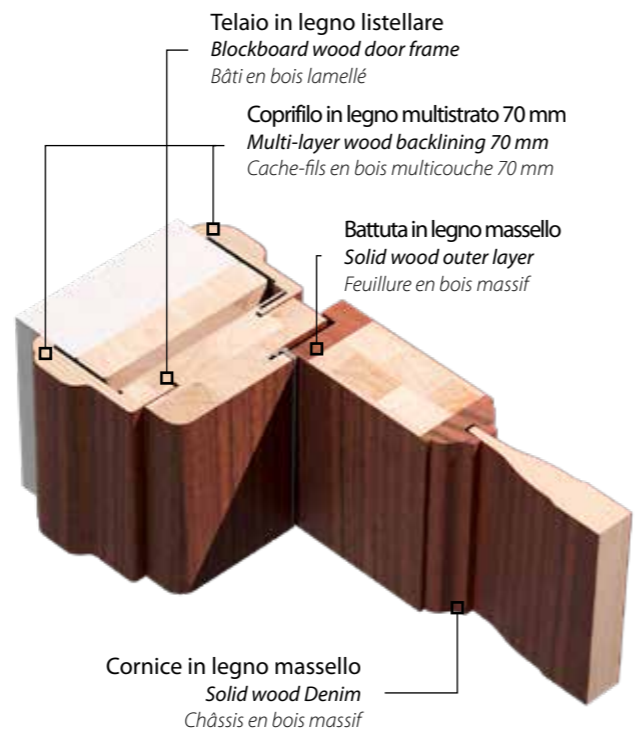
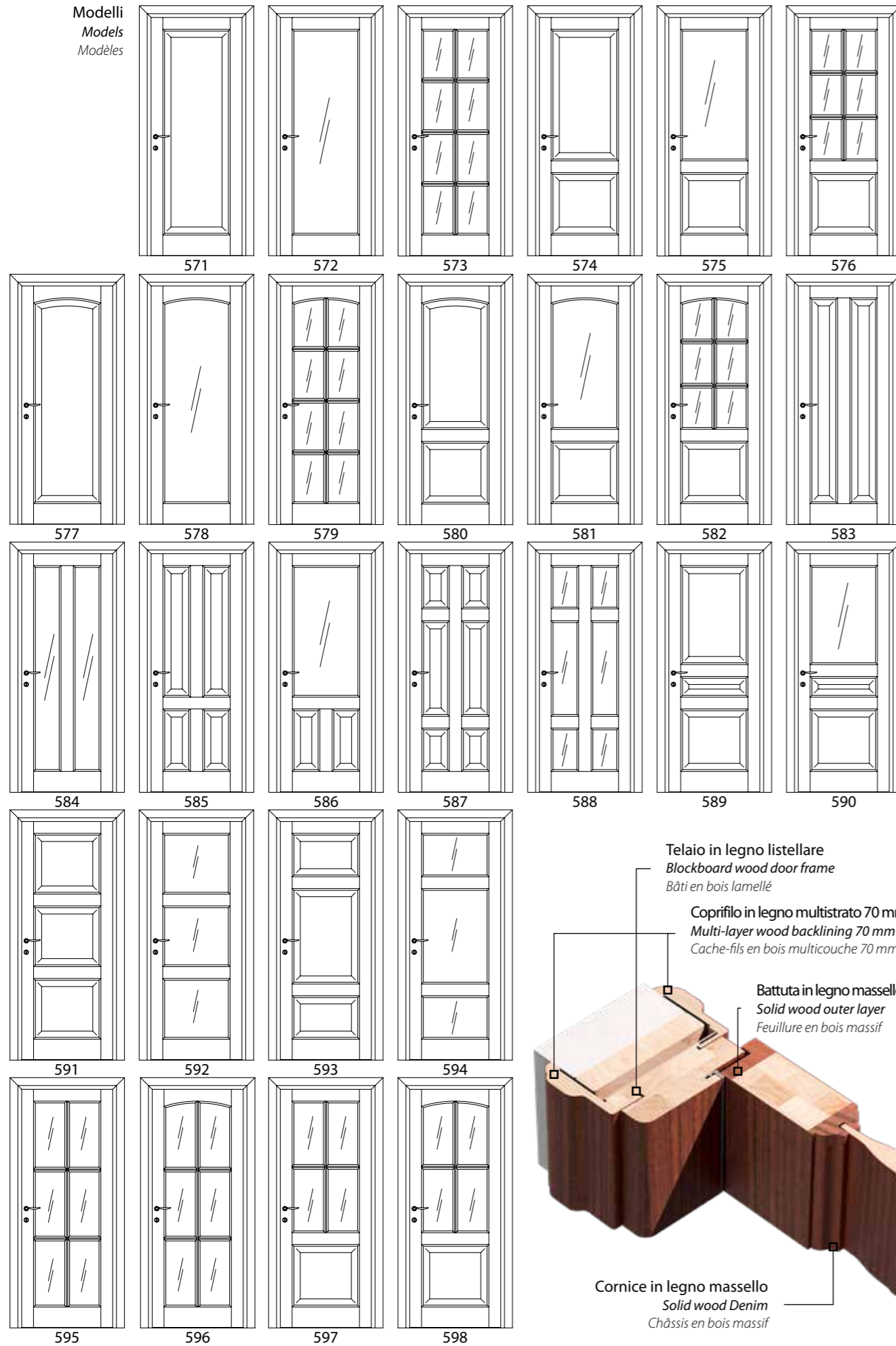

Finiture e laccature standard
Standard finishes and lacquer
Finitions et vernis en standard



Tanganica Tinto Ciliegio
Tanganika Dyed Cherry
Tanganika Teinté Cerise



Tanganica Tinto Medio
Tanganika Dyed Medium
Tanganika Teinté Moyenne



Rovere Tinto Miele
Oak Dyed Honey
Chêne Teinté Miel

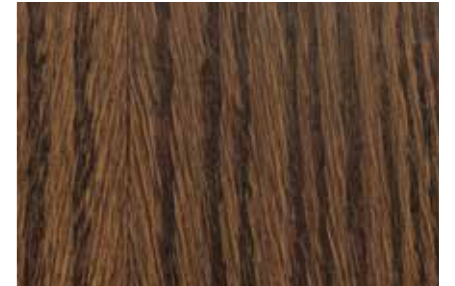

Rovere Tabacco
Oak Tobacco
Chêne Tabac

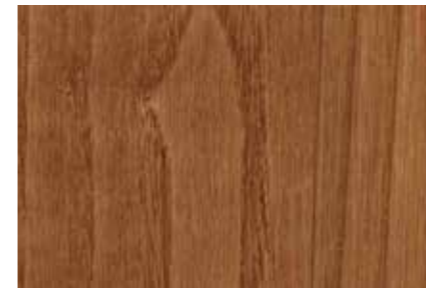

Castagno Tinto Medio
Chestnut Dyed Medium
Châtaigne Teinté Moyenne



Noce Nazionale Tinto Medio
Italian Walnut Dyed Medium
Noyer Italien Teinté Moyenne



Castagno Laccato a Poro aperto RAL
Open Pore Lacquered RAL Chestnut
Châtaigne Laqué Pore ouvert RAL



Castagno Decò L2
Decò L2 Chestnut
Châtaigne Decò L2



Castagno Decò L1
Decò L1 Chestnut
Châtaigne Decò L1

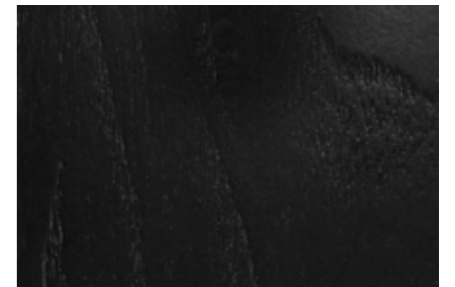

Castagno Laccato a Poro aperto RAL 9005
Open Pore Lacquered RAL 9005 Chestnut
Châtaigne Laqué Pore ouvert RAL 9005

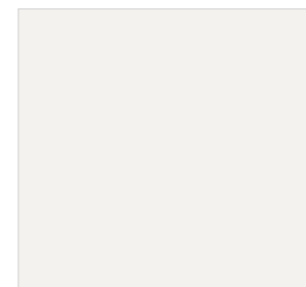

Laccato RAL 9003
Laquered RAL 9003
Laqué RAL 9003

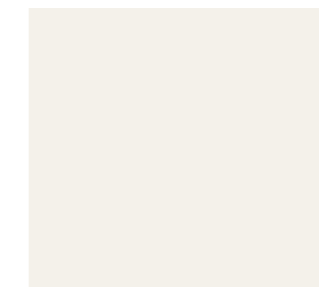

Laccato RAL 9010
Laquered RAL 9010
Laqué RAL 9010

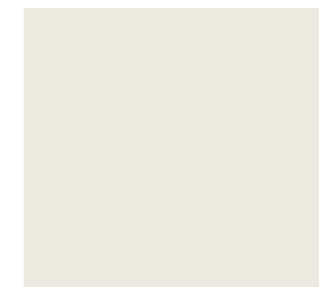

Laccato RAL 9001
Laquered RAL 9001
Laqué RAL 9001

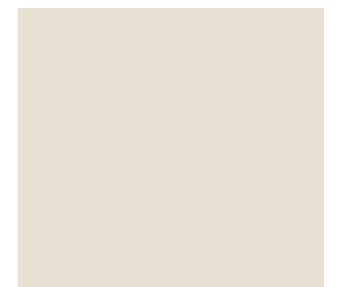

Laccato RAL 1013
Laquered RAL 1013
Laqué RAL 1013



Altri colori RAL su richiesta / Other RAL colors on request / Autres couleurs RAL sur demande

Verificare su mazzetta i colori reali, quelli riportati sul presente catalogo sono puramente indicativi
Check wad of real colors, as shown in this catalog are purely indicative
Vérifiez liasse de couleurs réelles, comme indiqué dans ce catalogue sont purement indicatives

Imbotti

Imbotte - Raggio 10 con cerniera anuba
Door jamb - Radius 10 with anuba hinge
Intrados - Rayon 10 avec charnière anuba

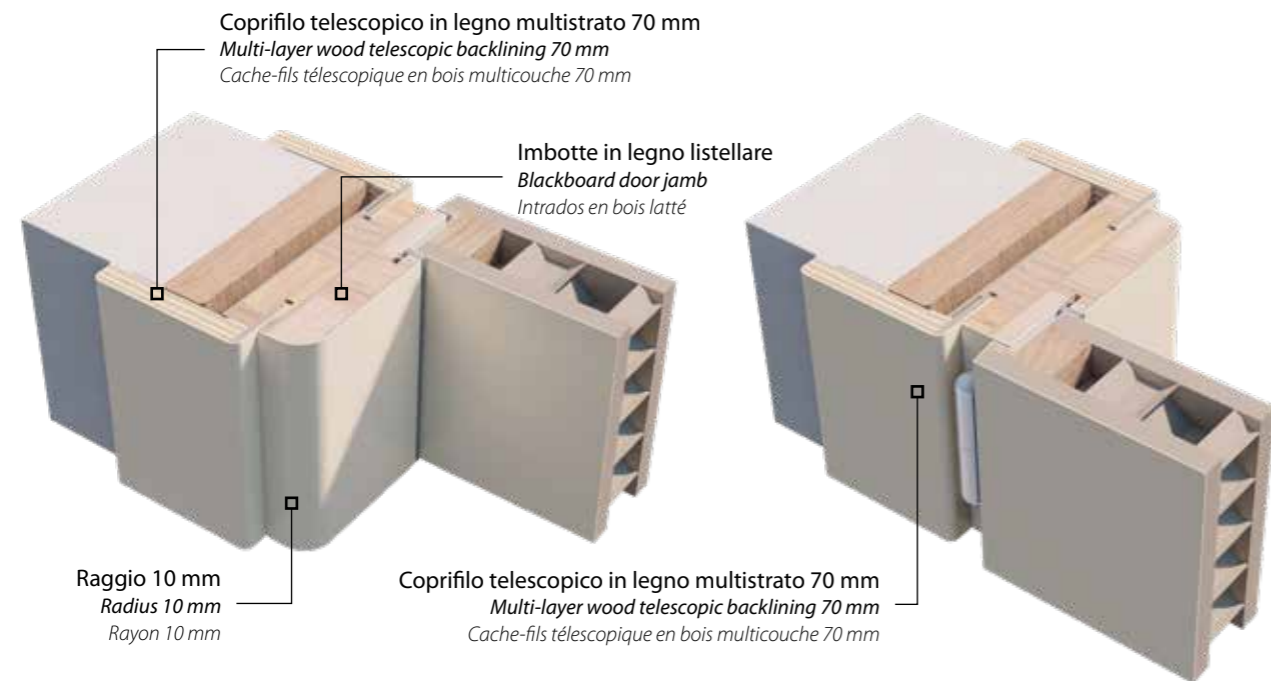

Imbotte - Raggio 2 con cerniera a scomparsa
Door jamb - Radius 2 with hidden hinge
Intrados - Rayon 2 avec charnière rétractable

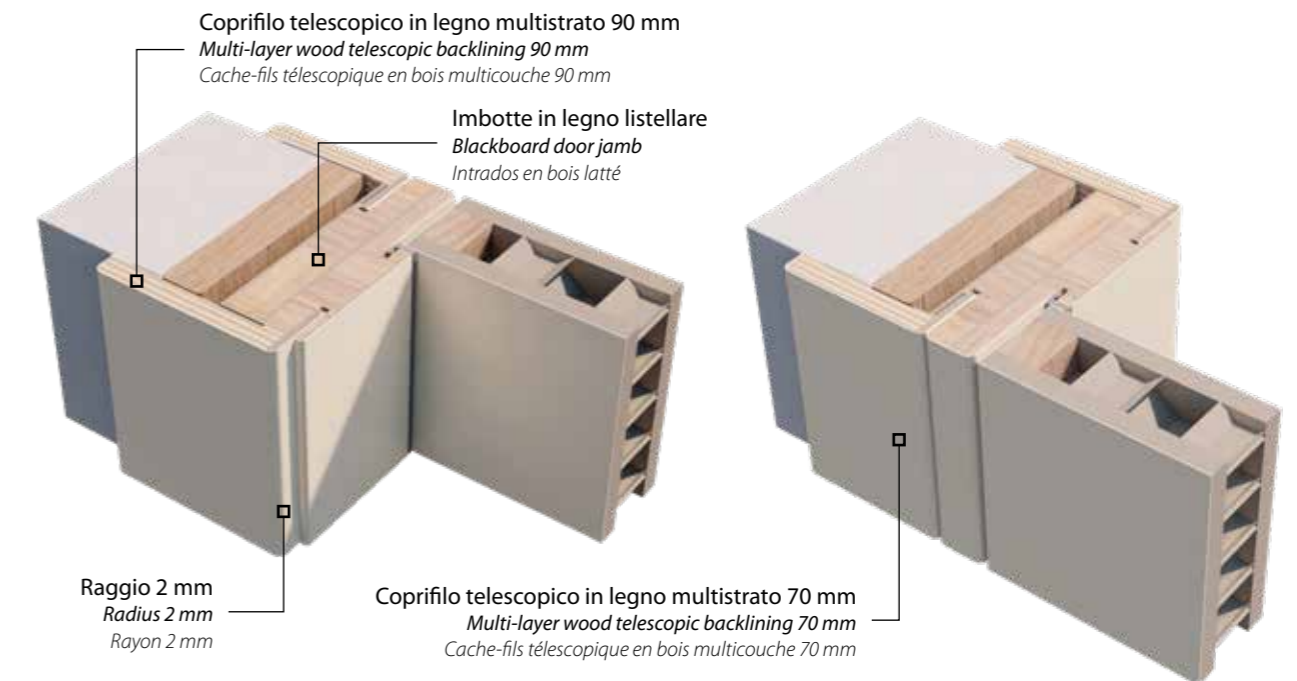

Imbotte - Raggio 2 con cerniera anuba
Door jamb - Radius 2 with anuba hinge
Intrados - Rayon 2 avec charnière anuba

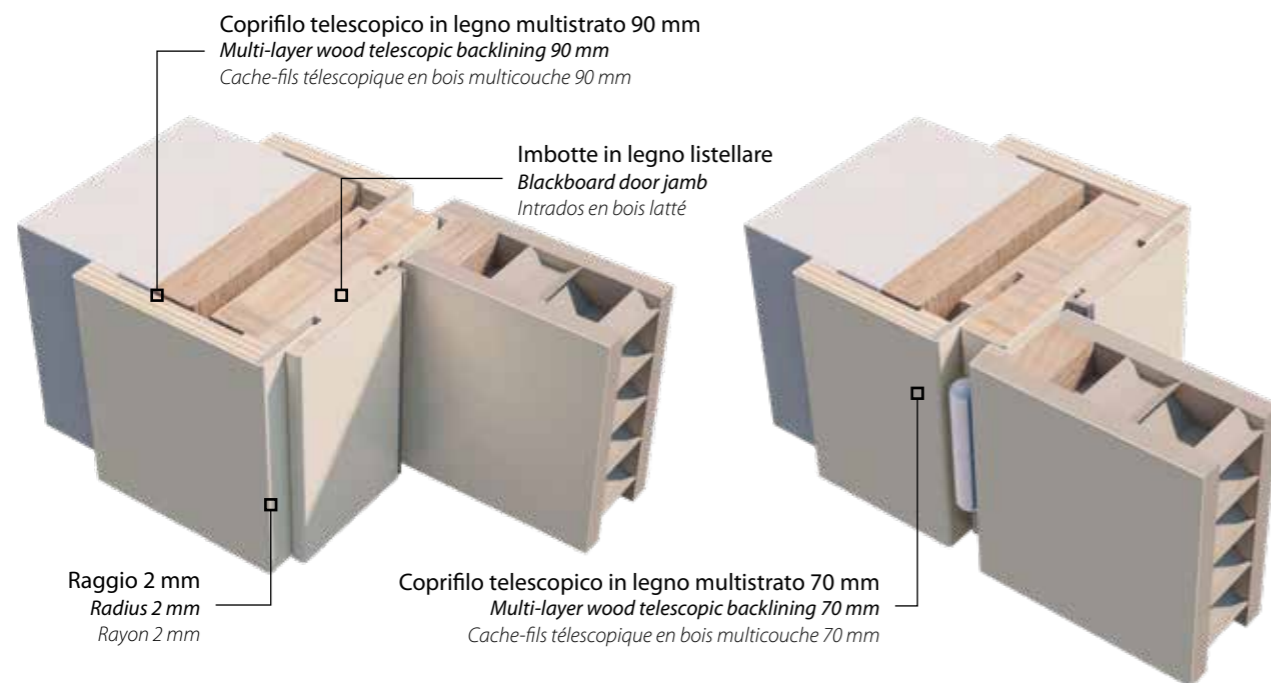

Imbotte - Raggio 2 con cerniera a bilico
Door jamb - Radius 2 door jamb with pivot hinge
Intrados - Rayon 2 avec charnière à pivot

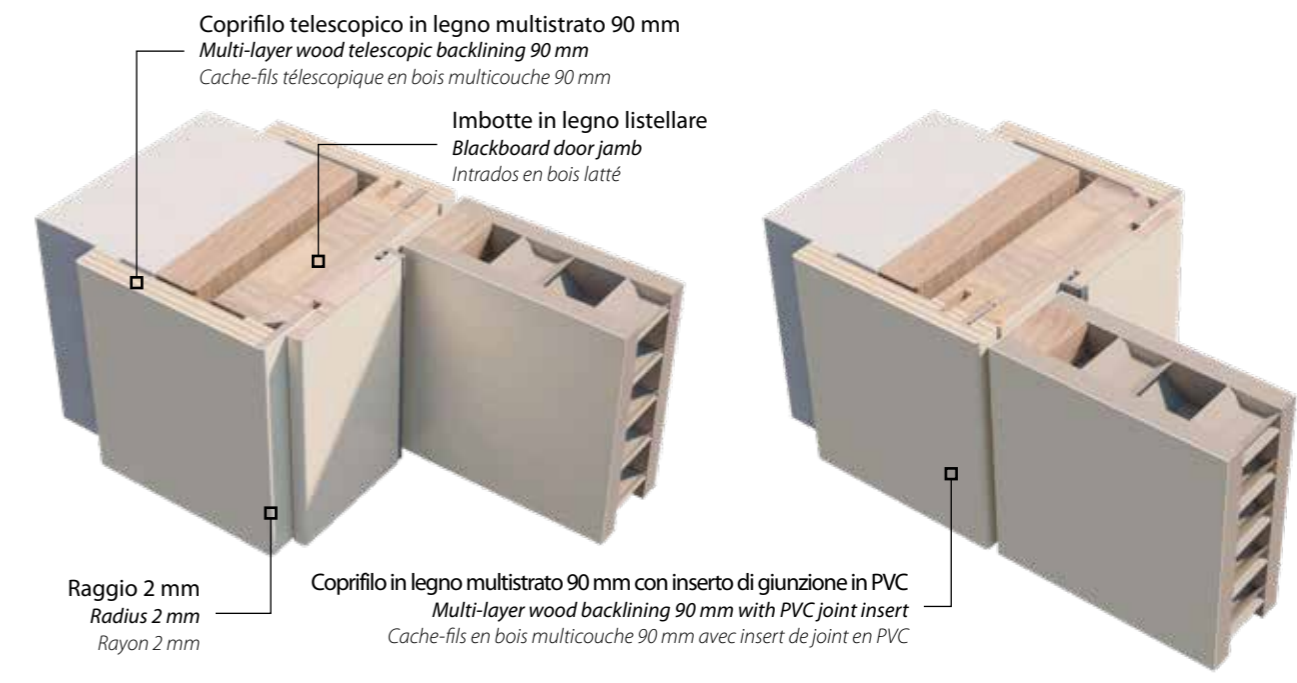

Per le collezioni Segno, Stile, Tosca, Butterfly, Turandot sono disponibili i seguenti imbotti alternativi: imbotte Raggio 2 con cerniera anuba, solo spessore mm.100 (mm.120 con coprifili telescopici); imbotte Raggio 2 con cerniera a bilico; imbotte Raggio 2 con cerniera a scomparsa solo per laccato e Rovere.

The following alternative upholstery is available for the Segno, Stile, Tosca, Butterfly, Turandot collections: Radius 2 upholstery with anuba hinge, only for lacquered and only 100 mm thick (120 mm with telescopic trims); Radius 2 upholstery with pivot hinge only for lacquered; Radius 2 upholstery with concealed hinge only for lacquered and oak.

Les revêtements alternatifs suivants sont disponibles pour les collections Segno, Stile, Tosca, Butterfly, Turandot : revêtement Raggio 2 avec charnière anuba, uniquement pour laqué et seulement 100 mm d'épaisseur (120 mm avec les garnitures télescopiques) ; Rembourrage Raggio 2 avec charnière pivotante uniquement pour laqué ; Rembourrage Raggio 2 avec charnière cachée uniquement pour laqué et chêne.

Per la collezione Otello sono disponibili i seguenti imbotti alternativi: imbotte Raggio 2 con cerniera anuba, solo per laccato e solo spessore mm.100 (mm.120 con coprifili telescopici); imbotte Raggio 2 con cerniera a bilico solo per laccato; imbotte Raggio 2 con cerniera a scomparsa solo per laccato e Rovere.

The following alternative upholstery is available for the Otello collection: Radius 2 upholstery with anuba hinge, only for lacquered and only 100 mm thick (120 mm with telescopic trims); Radius 2 upholstery with pivot hinge only for lacquered; Radius 2 upholstery with concealed hinge only for lacquered and oak.

Les revêtements alternatifs suivants sont disponibles pour la collection Otello : revêtement Radius 2 avec charnière anuba, uniquement pour laqué et seulement 100 mm d'épaisseur (120 mm avec les garnitures télescopiques) ; Rembourrage Radius 2 avec charnière pivotante uniquement pour laqué ; Rembourrage Radius 2 avec charnière cachée uniquement pour laqué et chêne.

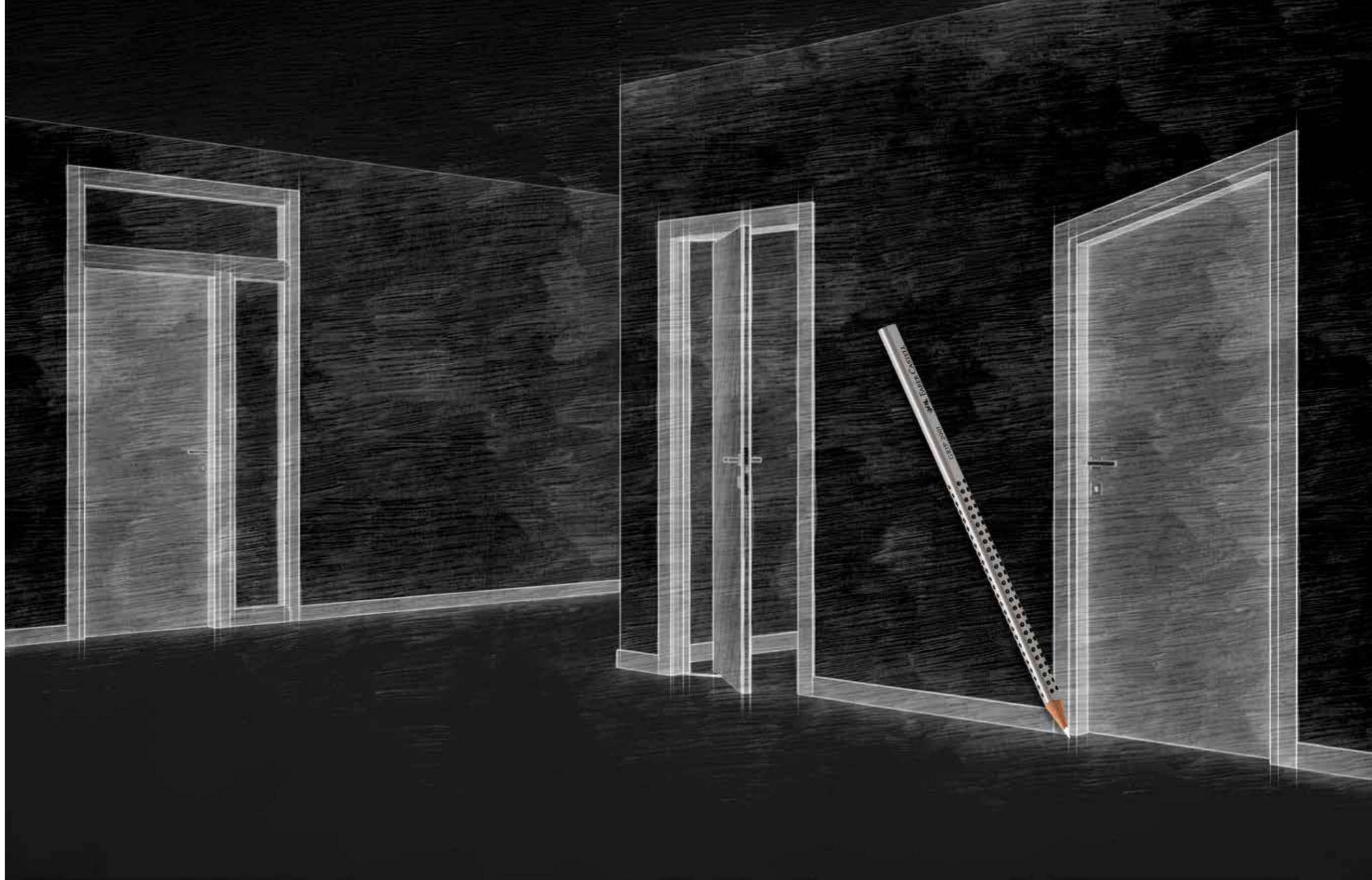

Porte speciali

Porte speciali e accessori

Per risolvere con stile ogni problema di spazio e soddisfare ogni esigenza progettuale OTC DOORS offre una serie di meccanismi di apertura e soluzioni progettuali speciali.

Special doors and accessories

To solve all problems of space with style and to satisfy all planning requirements, OTC DOORS offers a series of special design opening mechanisms and solutions.

Portes spéciales et accessoires

Pour résoudre avec style n'importe quel problème d'espace et satisfaire n'importe quelle exigence conceptuelle, OTC DOORS propose une série de mécanismes d'ouverture et de solutions conceptuelles spéciales.

Porte speciali
Special doors
Portes spéciales

Sistemi di apertura speciali disponibili per la maggior parte dei modelli di tutte le collezioni OTC DOORS. Per altre soluzioni speciali richiedere fattibilità e prezzo.

Special opening systems available for most of the models of all the OTC DOORS collections. For other special solutions require feasibility and price.

Systèmes d'ouverture spéciaux disponibles pour la plupart des modèles de toutes les portes collections de gré à gré. Pour d'autres solutions spéciales exigent la faisabilité et le prix.



Scorrevole a scomparsa con serratura
Fully-retracting sliding door with lock
Porte coulissante escamotable, avec serrure



Scorrevole esterno parete con serratura
Exposed sliding door with lock
Porte coulissante externe paroi, avec serrure



Altezza standard 210 cm
Standard height
Hauteur standard



Altezza 240 cm
Height 240 cm
Hauteur 240 cm



Altezza a soffitto
Height to ceiling
Hauteur au plafond



Vano passaggio
Door width
Passage ouvert



1/3 2/3



Libro
Folding door
Porte pliante



Sopraluce e/o visiva laterale
Fanlight opener and/or side window
Imposte optionnel

Rototraslante. Un movimento unico, su entrambi i lati, di rotazione e traslazione, consente di ridurre di circa il 50% l'area impegnata dalla porta rispetto alle normali porte a battente. L'innovativo sistema di OTC DOORS, grazie all'assenza della barra centrale, permette di utilizzare qualsiasi porta, con e senza vetro, rendendo possibile l'impiego di una rototraslante in ogni tipo di ambiente.

Rototranslating. A unique rotating and translating movement on both sides reduces the area covered by the door by about 50%, compared with a standard wing doors. Having no central bar, OTC DOORS' innovative system can be applied to any door, with or without a glass, so the rototranslating door may be used in any space of your home.

Pivotante. Un mouvement unique, des deux côtés, de rotation et de déplacement, qui permet de réduire d'environ 50% la prise d'air dans la porte par rapport aux portes battantes traditionnelles. Le système innovant d'OTC DOORS, grâce à l'absence de la barre centrale, permet d'utiliser n'importe quelle porte, avec ou sans verre; rendant ainsi possible l'utilisation d'une porte pivotante dans n'importe quel intérieur.



Rototraslante 1
Rototranslating 1
Pivotante 1



Raso muro
Flush wall
Invisible



Filo imbotte
Blockboard coplanar
Bâti coplanaires



Porta in pendenza
Sloping door
Porte en pente



Rototraslante 2
Rototranslating 2
Pivotante 2



Rototraslante 3
Rototranslating 3
Pivotante 3



Rototraslante 4
Rototranslating 4
Pivotante 4

Qualunque sia il progetto

OTC DOORS è un produttore diretto. Ciò significa che per ogni progetto, sia di serie che personalizzato, ogni fase di sviluppo e realizzazione, dalla scelta dei materiali migliori alle soluzioni di montaggio più performanti, è seguita direttamente dall'azienda. Questa è la premessa fondamentale per distinguere i prodotti OTC DOORS dalla concorrenza italiana e straniera. Grazie a una struttura produttiva flessibile e alla competenza di personale qualificato con esperienza pluriennale, OTC DOORS è in grado di studiare soluzioni personalizzate e su misura anche in piccole quantità.

Whatever the project OTC DOORS is a direct manufacturer. Which means that for every project, be it standard or bespoke, each phase of development is carried out, from the choice of materials to the best performing assembly solutions, and followed closely by the company. This is the fundamental premise for distinguishing OTC DOORS products from Italian and foreign competition. Thanks to a flexible production structure and to the competence of qualified personnel with many years' experience, OTC DOORS is able to perfect personalized and made to measure solutions, even for small quantities.

Quel que soit le projet OTC DOORS est un fabricant direct. Ceci signifie que pour chaque projet, aussi bien de série que personnalisé, chaque phase de développement et de réalisation, du choix des meilleurs matériaux aux solutions de montage les plus performantes, est suivie directement par l'entreprise. C'est le principe fondamental pour distinguer les produits OTC DOORS de la concurrence italienne et étrangère. Grâce à une structure de la production souple et aux compétences du personnel qualifié avec expérience pluriennale, OTC DOORS est en mesure d'étudier des solutions personnalisées et sur mesure même en petites quantités.



Sistemi di chiusura e maniglie

	Butterfly	Dual	Granducato	Otello	Rasomuro	Segno	Stile	Tosca	Turandot	Ventiventi
Serratura Evolution <i>Lock Evolution</i> <i>Serrure Evolution</i>	standard	-	standard	standard	-	standard	standard	standard	standard	standard
Incontro <i>Connection</i> <i>Réunion</i>	standard	-	standard	standard	-	standard	standard	standard	standard	standard
Cerniera anuba <i>Anuba hinge</i> <i>Charnière anuba</i>	standard	-	standard	standard	-	standard	standard	standard	standard	standard
Cerniera anuba Granducato <i>Anuba hinge Granducato</i> <i>Charnière anuba Granducato</i>	-	-	standard	-	-	-	-	-	-	-
Serratura magnetica <i>Magnetic closure system</i> <i>Serrure magnétique</i>	optional	standard	optional	optional	standard	optional	optional	optional	optional	optional
Incontro registrabile <i>Adjustable connection</i> <i>Rencontre modulable</i>	optional	optional	optional	optional	standard	optional	optional	optional	optional	optional
Cerniera a scomparsa <i>Hidden hinge</i> <i>Charnière rétractable</i>	optional	optional	optional	optional	standard	optional	optional	optional	optional	-
Cerniera a bilico <i>Pivot hinge</i> <i>Charnière à pivot</i>	optional	standard	optional	optional	-	optional	optional	optional	optional	optional
Rostro centrale registrabile <i>Central adjustable rostrum</i> <i>Tribune centrale réglable</i>	optional	standard	optional	optional	-	optional	optional	optional	optional	optional

Serratura Evolution
Lock Evolution
Serrure Evolution

Incontro
Connection
Réunion

Cerniera anuba
Anuba hinge
Charnière anuba

Cerniera anuba Granducato
Anuba hinge Granducato
Charnière anuba Granducato

Cerniera a scomparsa
Hidden hinge
Charnière rétractable

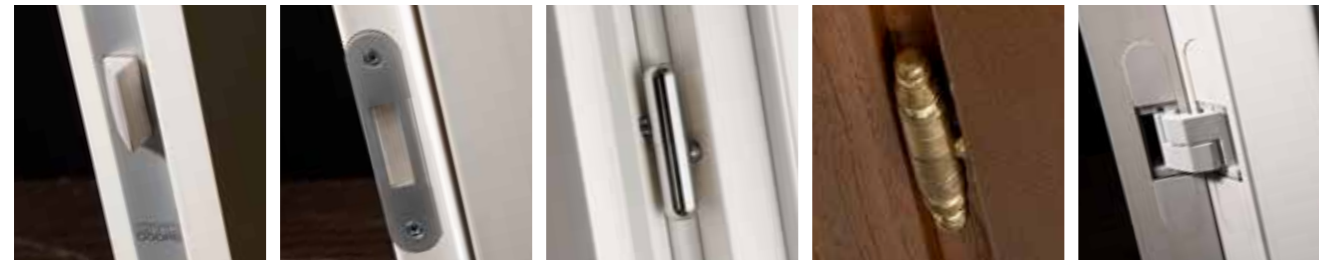

standard optional
Cromo satinato Cromo lucido
Ottone lucido Bronzo

standard optional
Cromo satinato Cromo lucido
Ottone lucido Bronzo

standard optional
Cromo satinato Cromo lucido
Ottone lucido Bronzo

standard optional
Ottone lucido Bronzo

standard
Cromo satinato
Ottone lucido
Bianco
Cromo lucido

Serratura magnetica
Magnetic closure system
Serrure magnétique

Incontro registrabile
Adjustable connection
Rencontre modulable

Cerniera a bilico
Pivot hinge
Charnière à pivot

Rostro centrale registrabile
Central adjustable rostrum
Tribune centrale réglable



standard
Cromo satinato
Ottone lucido
Bianco
Cromo lucido



















standard
Cromo satinato
Ottone lucido
Bianco

standard
Cromo satinato
Ottone lucido
Bianco
Cromo lucido

standard
Cromo lucido

maniglie handless poignées

<p>Giove</p> <p>Alluminio cromo satinato</p>	<p>GM07</p> <p>Cromo Lucido</p> <p>Cromo satinato</p>	<p>Toy</p> <p>Cromo Satinato</p> <p>Cromo lucido Nero opaco Ral 9010 opaco Bronzo graffiato opaco Ottone satinato opaco</p>
<p>York</p> <p>Cromo satinato</p> <p>Cromo lucido Nero opaco</p>	<p>Rialto</p> <p>Cromo satinato</p> <p>Cromo lucido Nero opaco</p>	<p>Cartesio Q</p> <p>Cromo lucido/satinato</p>
<p>Cartesio Q B/W</p> <p>Cromo lucido/Nero opaco</p> <p>Cromo lucido bianco</p>	<p>Wing</p> <p>Cromo satinato</p> <p>Cromo lucido</p>	<p>Atlanta</p> <p>Cromo satinato</p> <p>Cromo lucido Bronzo Yester Bianco Monviso Nero Etna</p>
<p>Baar</p> <p>Nero Etna</p>	<p>Pepe</p> <p>Bronzo Yester</p> <p>Cromo lucido Cromo satinato Bianco Monviso Nero Etna</p>	<p>Pure</p> <p>Cromo lucido</p> <p>Bianco Monviso Bronzo Yester Cromo satinato Nero Etna</p>
<p>Galileo</p> <p>Cromo lucido/satinato</p>	<p>Linea</p> <p>Titanium</p> <p>Cromo lucido Nero opaco</p>	<p>Nion</p> <p>Cromo satinato</p> <p>Cromo lucido Nero opaco Ral 9010 opaco Bronzo graffiato opaco Ottone satinato opaco</p>

<p>Leaf</p> <p>Cromo lucido</p>  <p>Cromo satinato Nero opaco</p> 	<p>Farfalla</p> <p>Cromo lucido</p>  <p>Cromo satinato Nero opaco Titanium</p> 	<p>Uno</p> <p>Cromo Satinato</p>  <p>Ottone lucido</p> 
<p>Aria</p> <p>Lato interno</p> <p>Nero opaco</p>  <p>Alluminio naturale</p> 	<p>Lato esterno</p> <p>Nero opaco</p>  <p>Alluminio naturale</p> 	<p>Shark</p> <p>Cromo satinato</p>  <p>Cromo lucido Ottone lucido</p> 
<p>Milena</p> <p>Cromo satinato</p> 	<p>Luna</p> <p>Alluminio cromo satinato</p> 	<p>Victoria</p> <p>Ottone lucido</p> 
<p>Novecento</p> <p>Ottone anticato naturale</p>  <p>Ottone ferro antico Ottone lucido verniciato Ottone brunito</p> 	<p>Serratura con nicchia incassata per rasomuro</p> 	<p>Nicchia per libro</p> <p>standard Cromo satinato Ottone lucido optional Cromo lucido Bronzo</p> 

Maniglie a incasso per porte scorrevoli
Built-in handles for sliding doors
Poignées intégrées

<p>Tonda - Standard</p> <p>standard Cromo satinato Ottone lucido optional Cromo lucido Bronzo</p> 	<p>Tonda - Con chiave</p> <p>optional Cromo satinato Ottone lucido Cromo lucido Bronzo</p> 	<p>Quadra - Optional</p> <p>optional Cromo satinato Cromo lucido</p> 
<p>Tonda - Standard con serratura</p> <p>standard Cromo satinato Ottone lucido optional Cromo lucido Bronzo</p> 	<p>Quadra - Optional con serratura</p> <p>optional Cromo satinato Cromo lucido</p> 	<p>Quadra - Con chiave</p> <p>optional Cromo satinato Cromo lucido</p> 

Maniglioni
Pull Handles
Poignées

<p>York Diritto H 250 mm</p> <p>Cromo satinato</p>  <p>Cromo lucido Nero opaco</p> 	<p>York a C H 320 mm</p> <p>Cromo satinato</p>  <p>Cromo lucido Nero opaco</p> 	<p>Euclide H 260 mm</p> <p>Cromo lucido/satinato</p> 	<p>Modulare H 400-500-1000-1700 mm</p> <p>Cromo satinato</p> 
<p>Sogno H 220 mm</p> <p>Cromo satinato</p>  <p>Cromo lucido Ottone lucido Nero opaco Ottone lucido PVD</p> 	<p>Quadro LxL 25x25 H 500/600 mm</p> <p>Cromo satinato</p>  <p>Cromo lucido</p> 	<p>Tondo Ø 25 H 500/600 mm</p> <p>Cromo satinato</p>  <p>Cromo lucido</p> 	
<p>Cometa H 220 mm</p> <p>Ottone lucido verniciato</p>  <p>Cromo lucido Cromo satinato Ottone lucido PVD</p> 	<p>Airone H 220 mm</p> <p>Ottone lucido verniciato</p>  <p>Cromo lucido Cromo satinato Ottone lucido PVD</p> 		

Battiscopa e portali

Realizzati con le stesse finiture delle collezioni OTC DOORS, con la loro prestazione estetica e funzionale, i battiscopa costituiscono il naturale complemento della porta nell'ambiente. Le varie dimensioni sono studiate per dare continuità alla linea del coprifilo delle porte interne e dei portoni blindati sia nelle dimensioni che nei colori, che sono disponibili in tutte le finiture di serie e nella gamma di laccature RAL anche con colori su richiesta. Inoltre è possibile variare imbotti e coprifili scegliendo tra 3 modelli di portale che conferiscono alla porta grande prestigio e maestosità. I portali sono disponibili nelle essenze Castagno e nelle finiture Decò e laccati.

Skirting and portals
 Made with the same finishes as the OTC DOORS collections, with their aesthetic and functional characteristics, the skirting boards are a natural complement to a door in any environment. The various dimensions designed to offer continuity to the lines of casings for internal and security doors, be it for their dimensions or colour, and which are available in all the stock finishes and in the range of RAL lacquers, or also in requested colours. Furthermore, it is possible to vary jamba and casings, choosing from 3 models of front door to which they confer great prestige and majesty. The front doors are available in solid Chestnut as well as in Deco and lacquered finishes.

Plinthe et portails
 Réalisés avec les mêmes finitions que les collections OTC DOORS, avec leur performance esthétique et fonctionnelle, les antibois constituent le complément naturel de la porte dans l'environnement. Les différentes dimensions sont étudiées pour garantir la continuité de la ligne du chambranle des portes internes et des grandes portes blindées aussi bien dans les dimensions que dans les couleurs, qui sont disponibles dans toutes les finitions de série et dans la gamme de laquages RAL, même avec des couleurs sur demande. En outre, il est possible de varier des en choisissant parmi 3 modèles de portail qui confèrent à la grande porte prestige et grandeur. Les portails sont disponibles dans les essences Castagno et dans les finitions Deco et laquées.

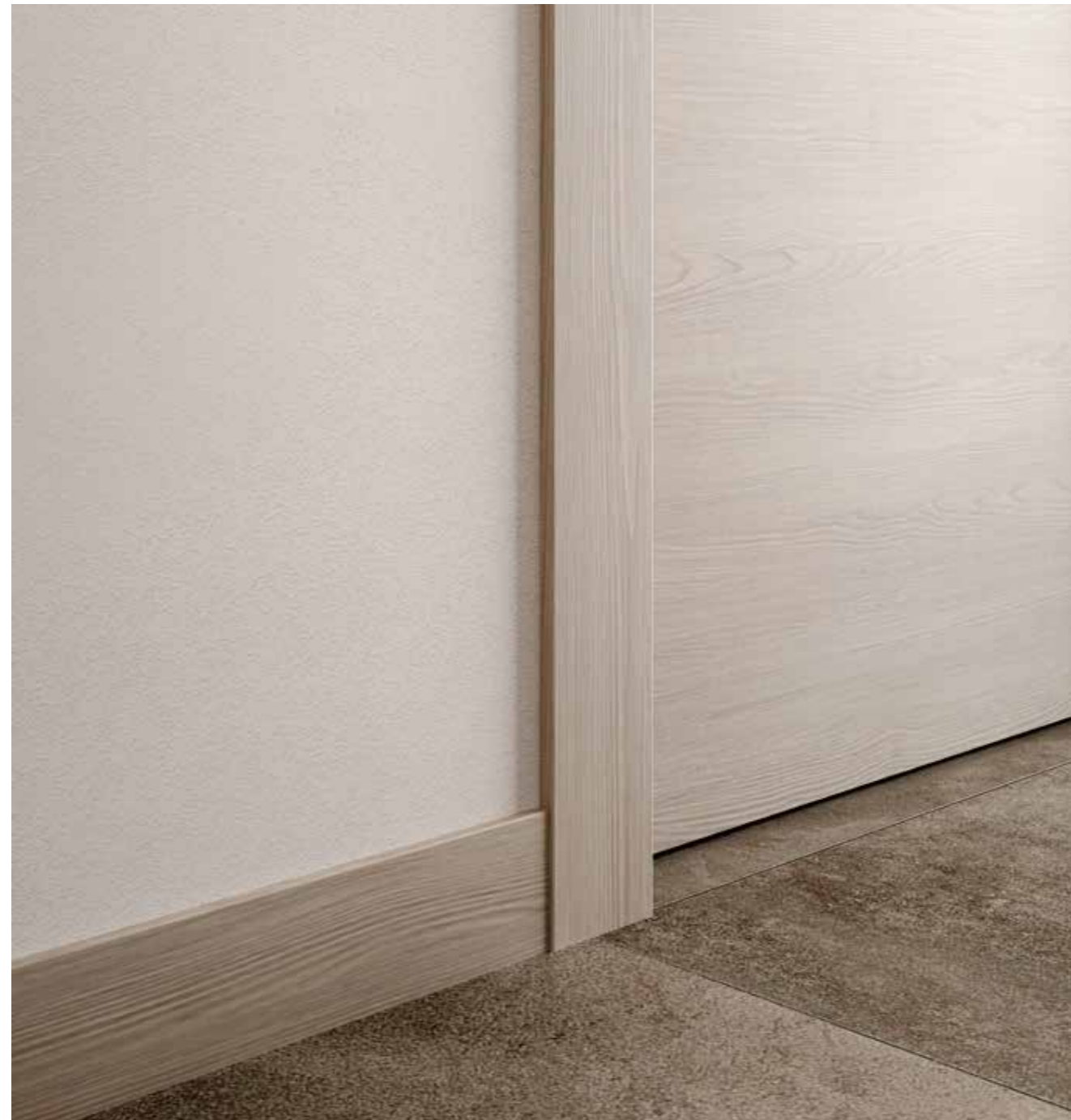

Battiscopa standard 70/75x10 mm per imbotta Raggio 10
 Standard skirting board 70/75 x 10 mm for frame extensions Radius 10
 Plinthes norme du Conseil 70/75 x 10 mm pour les extensions de cadre Rayon de 10

BUTTERFLY
 OTELLO
 GRANDUCATO
 TURANDOT
 TOSCA



Battiscopa standard 90x10 mm per imbotta New Style
 Standard skirting board 90 x 10 mm for frame extensions New Style
 Plinthes norme du Conseil 90 x 10 mm pour les extensions de cadre Rayon de 10

BUTTERFLY
 OTELLO
 TURANDOT
 TOSCA



Battiscopa standard 90x9/10 mm
 Standard skirting board 90 x 9/10 mm
 Plinthes norme du Conseil 90 x 9/10 mm

VENTIVENTI
 DUAL
 READY DOORS



Portali
 Portals
 Portails

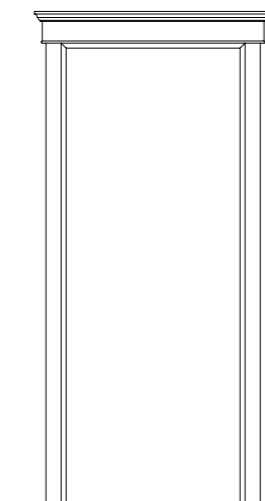

Impero

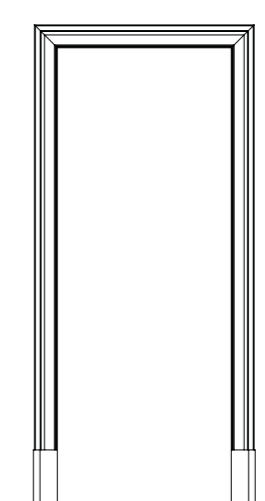

Palladio

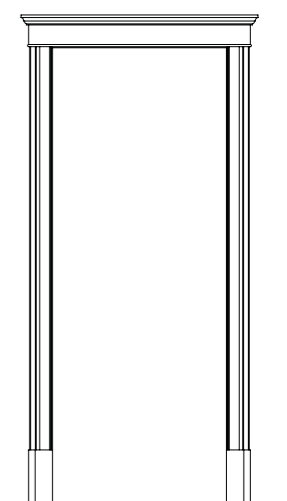

Venezia

riflessi



La magia del vetro

Un progetto di arredamento non può prescindere dalla possibilità di proporre soluzioni vetrate coordinate con il resto delle porte dell'ambiente. OTC DOORS fornisce un'ampia gamma di porte in vetro, dalla semplice finitura trasparente alla più sofisticata lavorazione, che, insieme ai numerosi sistemi di apertura, agli imbotti, ai coprifili e ai battiscopa sempre coordinati, è in grado di soddisfare qualsiasi esigenza estetica e funzionale.

A furnishing project cannot ignore the possibility of proposing coordinated glass solutions with the rest of the room's doors. OTC DOORS provides a wide range of glass doors, from the simple transparent finish to the most sophisticated manufacturing, which, together with the numerous opening systems, the coordinated frames, skirting board and architraves, is always able to satisfy any aesthetic and functional need.

Un projet de mobilier ne peut ignorer la possibilité de proposer des solutions de verre coordonnées avec le reste des portes de la pièce. OTC DOORS propose une large gamme de portes en verre, de la simple finition transparente à la fabrication la plus sophistiquée, qui, avec les nombreux systèmes d'ouverture, les cadres, les plinthes norme et les architectures coordonnés, est toujours en mesure de satisfaire tous les besoins esthétiques et fonctionnels.



TUTTO VETRO

Vetro Alpaca - Guida Ghost
Alpaca glass - Ghost sliding rail
Verre Alpaca - Rail de guidage Ghost

TUTTO VETRO

Scorrevole esterno, Vetro Donegal, guida Large
Exposed sliding door, Donegal glass, sliding rail Large
Porte coulissante externe paroi, Verre Donegal, rail de guidage Large





TUTTOVETRO

Scorrevole esterno, Vetro Tweed, guida Minima

Exposed sliding door, Tweed glass, sliding rail Minima

Porte coulissante externe paroi, Verre Tweed, rail de guidage Minima



Sistema Invisibile Evo

Disponibile sia per le porte tuttovetro che per quelle in legno, il sistema scorrevole Invisibile EVO si distingue per l'assenza di qualsiasi tipo di meccanismo a vista, anche quando la porta è aperta. La porta, come rappresentato nelle immagini, occupa, aperta, 15 cm del vano passaggio. Per lasciare libera tutta la luce del vano andrà utilizzata una porta più larga di 22 cm del vano stesso e collocata in posizione decentrata.

Available for both all-glass and wooden doors, the Invisibile EVO sliding system stands out for the absence of any type of visible mechanism, even when the door is open. The door, as shown in the images, occupies 15 cm of the passageway when open. To leave all the space light free, a door wider than 22 cm must be used and placed in a decentralized position.

Disponible pour les portes tout verre et en bois, le système coulissant Invisibile EVO se distingue par l'absence de tout type de mécanisme visible, même lorsque la porte est ouverte. La porte, comme le montrent les images, occupe 15 cm du passage lorsqu'elle est ouverte. Pour laisser tout l'espace libre de lumière, une porte de plus de 22 cm doit être utilisée et placée en position décentralisée.

TUTTO VETRO

Vetro Chiffon - Guida Invisibile Evo

Chiffon glass - Invisibile Evo sliding rail

Verre Chiffon - Rail de guidage Invisibile Evo



TUTTO VETRO

Porta a battente, vetro Iris carta
Hinged door, Iris carta glass
Porte battante, verre Iris carta



TUTTO VETRO

Scorrevole esterno, Vetro Ficus, guida Madera
Exposed sliding door, Ficus glass, sliding rail Madera
Porte coulissante externe paroi, Verre Ficus, rail de guidage Madera

TUTTO VETRO

WA4 - WB4 Vetro Anemone blu
WA4 - WB4 - Anemone blu glass
WA4 - WB4 Verre Anemone blu





TUTTO VETRO

Scorrevole a scomparsa, vetro Edera anta doppia
Fully-retracting sliding door, Edera anta doppia glass
Porte coulissante escamotable, verre Edera anta doppia



TUTTO VETRO

Scorrevole esterno, Vetro Albero anta doppia, guida Invisibile Evo
Exposed sliding door, Albero anta doppia glass, sliding rail Invisibile Evo
Porte coulissante externe paroi, Verre Albero anta doppia, rail de guidage Invisibile Evo

TUTTO VETRO

Vetro Giunco, guida Ghost
Giunco glass, sliding rail Ghost
Verre Giunco, rail de guidage Ghost

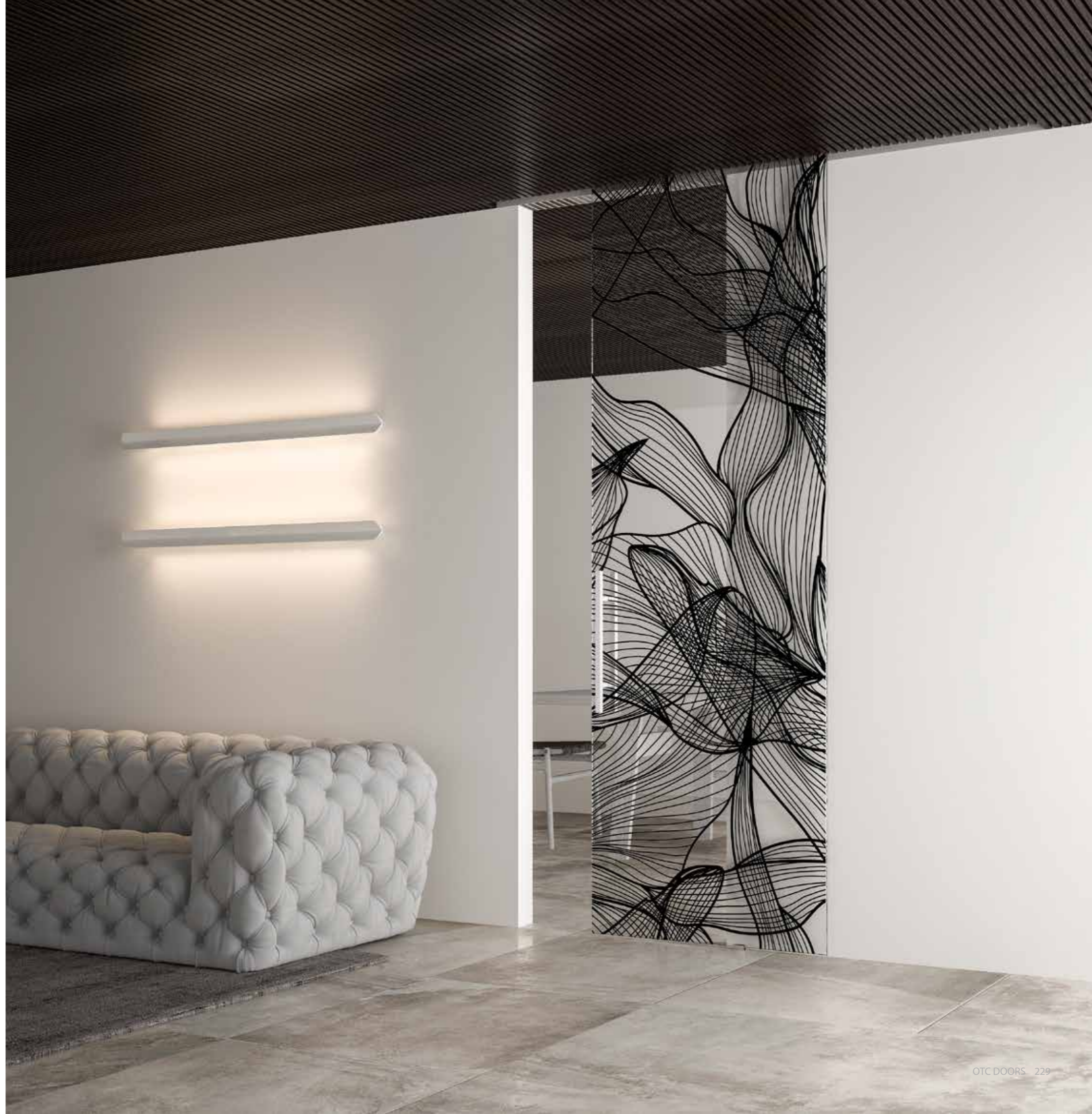



TUTTO VETRO

Vetro Iris nero, guida Ghost
Iris nero glass, sliding rail Ghost
Verre Iris nero, rail de guidage Ghost

TUTTO VETRO

Porta a battente, vetro Notte

Hinged door, Notte glass

Porte battante, verre Notte





TUTTO VETRO

Scorrevole esterno, Vetro Graffiti nero, guida Small
Exposed sliding door, Graffiti nero glass, sliding rail Small
Porte coulissante externe paroi, Verre Graffiti nero, rail de guidage Small



TUTTO VETRO

Porta a battente, vetro Astratto rosso
Hinged door, Astratto rosso glass
Porte battante, verre Astratto rosso

TUTTO VETRO

Scorrevole a scomparsa, vetro Astratto rosso
Fully-retracting sliding door, Astratto rosso glass
Porte coulissante escamotable, verre Astratto rosso



TUTTO VETRO

Anta va e vieni, vetro Astratto blu
Swing doors, Astratto blu glass
Vantail va-et-vient, verre Astratto blu



Sistema Anta va e vieni

Sistema ad un'anta va e vieni con cerniere metalliche montate su imbotte in legno, con apertura sia a spingere che a tirare. L'ingombro di apertura è pari alla larghezza dell'anta.

System of swing doors with metal hinges mounted on wooden door jambs, which open out as well as in. The opening obstruction is the same as the width of the door.

Système avec vantail va-et-vient avec charnières métalliques montées sur des éléments rembourrés en bois, avec ouverture aussi bien à pousser qu'à tirer. L'encombrement d'ouverture est égal à la largeur du vantail.

Le lavorazioni del vetro

Sicurezza ed estetica si incontrano nella collezione di porte interne OTC DOORS. Ogni vetro è sottoposto al trattamento di tempra che rende i nostri prodotti più robusti e sicuri poiché, in caso di rottura, il vetro si frantuma in piccoli pezzi smussati, poco pericolosi, impedendo così che porzioni grandi della lastra di vetro possano procurare ferite o mettere in pericolo l'incolumità degli utilizzatori.

I vetri base standard sono forniti in spessore 6 mm temperati (o 3+3 stratificati) quando inseriti nella porta oppure in spessore 8 mm temperati (o 4+4 mm temperati e stratificati) nel caso delle porte tutto vetro. Vetro trasparente extrachiaro disponibile su richiesta.

Le lavorazioni di stampa vengono effettuate su vetro stratificato trasparente o su lastra unica satinata. La stampa digitale è realizzata sul lato interno della lastra anteriore a cui poi si accoppia un'altra lastra di stesso spessore. Nel caso in cui si scelga una base satinata, la stampa viene realizzata su una lastra unica direttamente sulla satinatura. Grazie a tale procedimenti la decorazione assume una prospettiva tridimensionale esaltata dalla luce filtrante.

*The glass processing
Safety and aesthetics come together in the OTC DOORS internal door collection. Each glass pane is tempered and it makes our products more robust and safe as, should a window break, the glass shatters into small blunted pieces less harmful and, in so doing, we avoiding that large pieces of glass cause injury or compromise the safety of the user.*

The basic standard glasses are supplied in thicknesses of 6 mm tempered (or 3+3 laminated) when used as door panels, or in a thickness of 8 mm tempered (or 4+4 tempered and laminated) in the case of doors made entirely of glass. Extra clear transparent glass is available on request.

The printing processes are carried out on transparent laminated glass or on a single satin sheet.

Digital printing is made on the inner side of the front plate to which another plate of the same thickness is then coupled. If a satin base is chosen, the print is made on a single plate directly on the satin finish. Thanks to this procedure, the decoration takes on a three-dimensional perspective enhanced by the filtering light.

*Le traitement du verre
Sécurité et esthétique se rencontrent dans la collection de portes internes OTC DOORS. Chaque verre est soumis au traitement de trempage qui rend nos produits plus robustes et sûrs puisqu'en cas de rupture, le verre se brise en de petits morceaux biseautés, peu dangereux, empêchant ainsi que des grosses portions de la plaque en verre puissent provoquer des blessures ou mettre en danger la sécurité des utilisateurs.*

Les verres de base standards sont fournis avec une épaisseur de 6 mm trempés (ou 3+3 stratifiés) quand ils sont insérés sur la porte ou avec une épaisseur de 8 mm trempés (ou 4+4 mm trempés et stratifiés) dans le cas où les portes sont entièrement en verre. Verre transparent extra-clair disponible sur demande.

Les opérations d'impression, de gravure, de sablage et de satinage sont effectuées sur le verre feuilleté ou sur une plaque unique.

Les impressions numériques sont réalisées sur la face interne d'un verre feuilleté afin d'en garantir une protection absolue au cours du temps. Pour la collection « Les Pattern », le verre peut être satiné ou transparent ; l'éventuel satinage est réalisée sur la face externe de la plaque arrière. De cette manière, la vision de la gravure sera différente des deux côtés de la porte. Pour les verres « Sablées ou gravées », les opérations de sablage ou de gravure et l'éventuelle base satinée sont réalisées sur la face avant de la plaque.

vetro stratificato (trasparente)
laminated glass (transparent)
verre feuilleté (transparent)

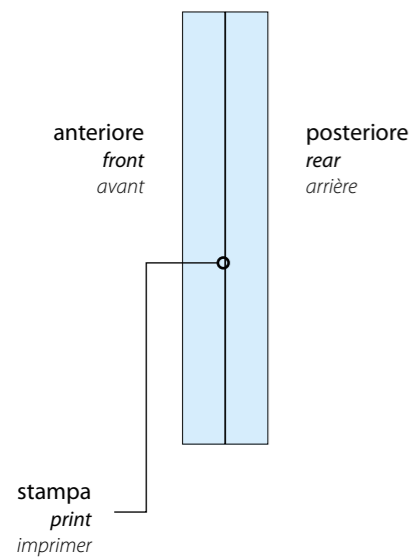

vetro lastra singola (satinato)
single glass plate (satin)
verre plaque unique (satinage)

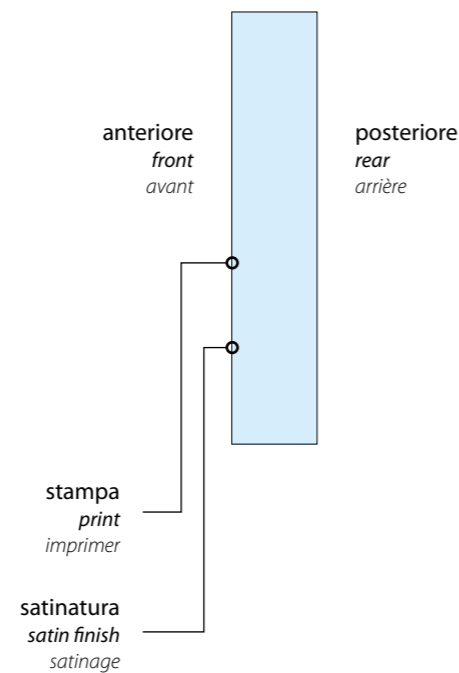

Vetri base standard

OTC DOORS mette a disposizione otto vetri standard che possono essere utilizzati direttamente, sia inseriti nelle porte interne che per porte tutto vetro, o impiegati come base per le varie decorazioni.

OTC DOORS offers eight standard glasses which could be used directly, whether on internal doors or for doors made entirely of glass, or used as a canvas for various decorative effects.

OTC DOORS met à disposition huit verres standards qui peuvent être utilisés directement, aussi bien insérés sur les portes interne que pour des portes entièrement en verre, ou utilisés comme base pour les différentes décorations.



trasparente | transparent | transparentes



bianco latte | milk white | blanc laiteux



specchio | mirror | miroir



satinato | frosted | satiné



fumé trasp. | transp. smoked | fumé transparentes



fumé satinato | frosted smoked | fumé satiné



bronzo trasp. | transp. bronze | bronze transparentes



bronzo satinato | frosted bronze | bronze satiné

Vetri stampati

Questa tipologia di vetri decorati è realizzata con tecnica mista su vetri stratificati e temperati di diversi spessori: 3+3 mm stratificati quando inseriti nella porta, 4+4 mm temperati e stratificati per il tutto vetro. Come illustrato nello schema a pagina 40, la stampa digitale è realizzata sul lato interno della lastra anteriore a cui poi si accoppia un'altra lastra di stesso spessore. Nel caso in cui si scelga una base satinata, la stampa viene realizzata su una lastra unica di 8 mm temperata direttamente sulla satinatura. Grazie a tale procedimenti la decorazione assume una prospettiva tridimensionale esaltata dalla luce filtrante.

This typology of decorated glass is made with a mixed technique on laminated and tempered glass of different thicknesses: 3+3 mm laminated when inserted into the door, 4+4 mm tempered and laminated for the whole glass. As shown in the diagram on page 40, digital printing is performed on the inner side of the front plate to which another plate of the same thickness is then coupled. If case of satin base, the print is made on a single 8 mm plate tempered directly on the satin finish. Thanks to this process, the decoration takes on a perspective enhanced by the filtering light.

Ce type de verre décoré est réalisé avec une technique mixte sur du verre feuilleté et trempé de différentes épaisseurs : 3 + 3 mm feuilleté lorsqu'il est inséré dans la porte, 4 + 4 mm trempé et feuilleté pour l'ensemble du verre. Comme le montre le schéma de la page 40, l'impression numérique est réalisée sur la face intérieure de la plaque avant à laquelle est ensuite couplée une autre plaque de même épaisseur. Si une base satinée est choisie, l'impression est réalisée sur une seule plaque de 8 mm trempée directement sur la finition satinée. Grâce à ce procédé, le décor prend une perspective tridimensionnelle renforcée par la lumière filtrante.



Astratto blu



Astratto rosso



Astratto verde



Astratto grigio



Edera Anta singola



Albero Anta singola

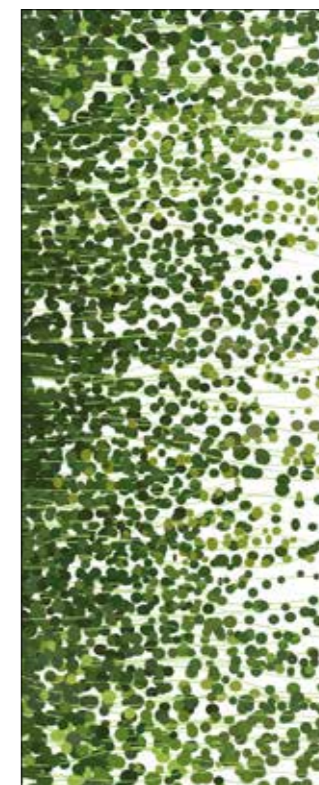

Edera Anta doppia sx



Albero Anta doppia sx

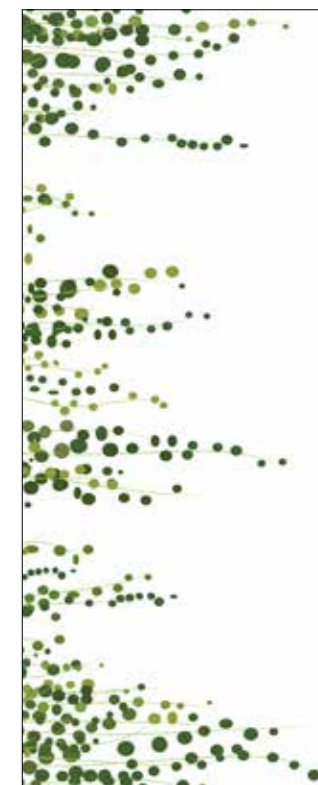

Edera Anta doppia dx



Albero Anta doppia dx



Foglie verdi



Foglie blu



Iris nero



Iris carta



Giunco



Ficus

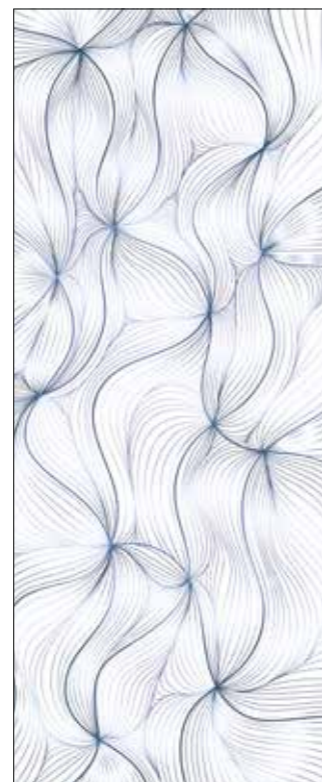

Anemone blu



Anemone nero

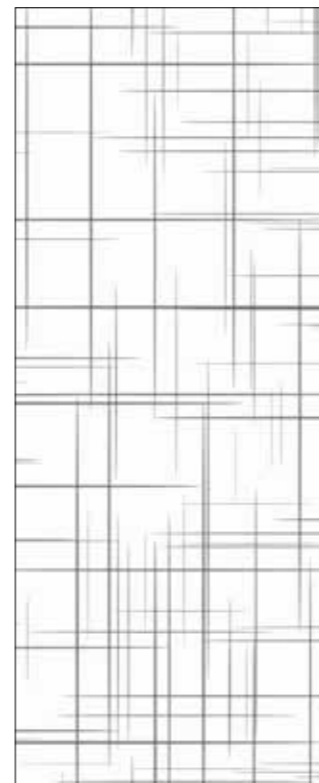

Chiffon



Tweed



Alpaca

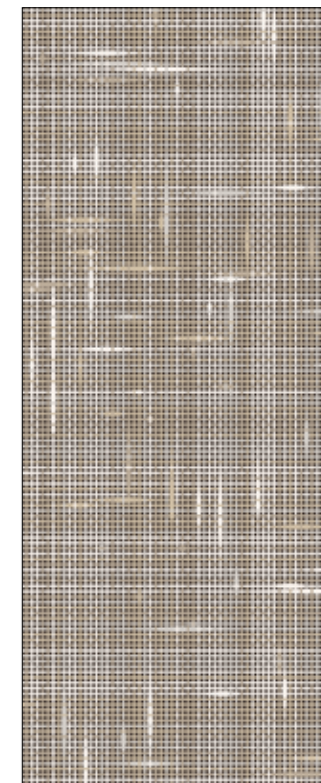

Donegal

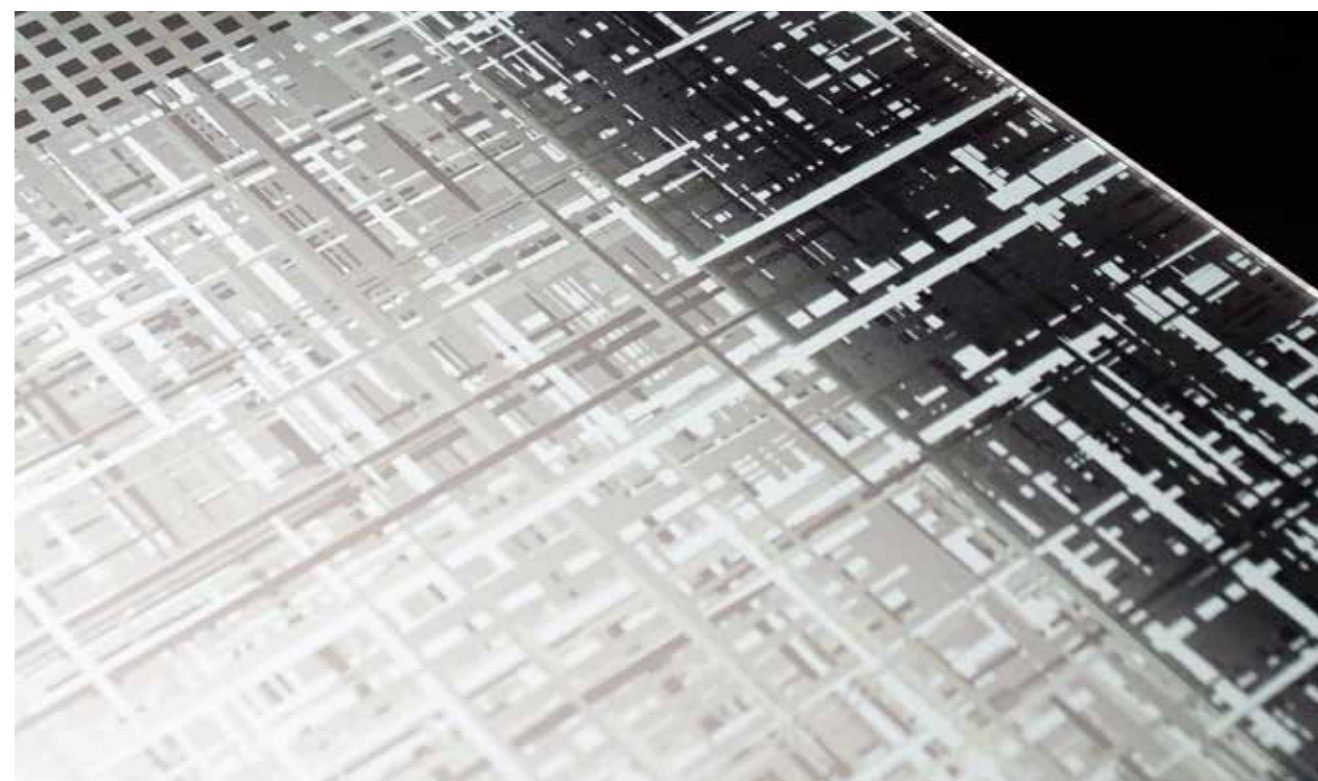

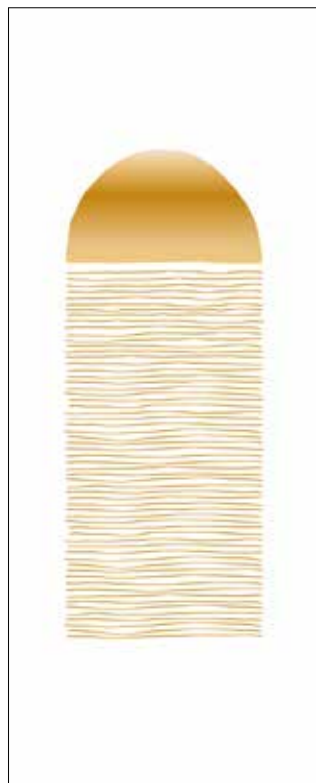

Tramonto

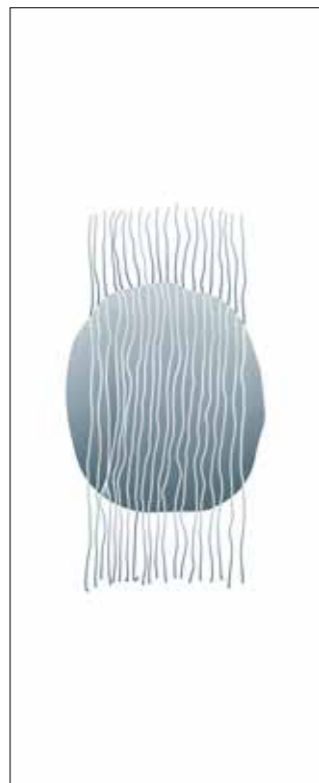

Notte

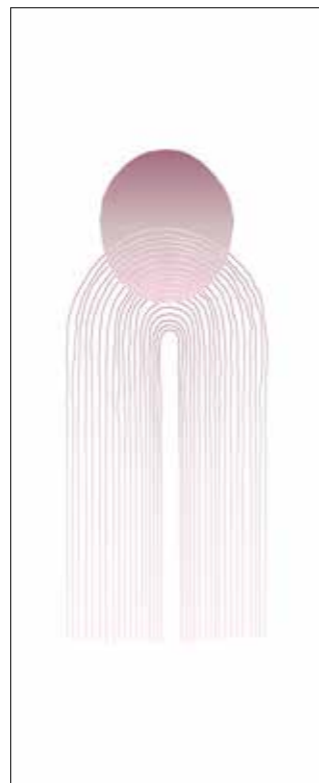

Meriggio

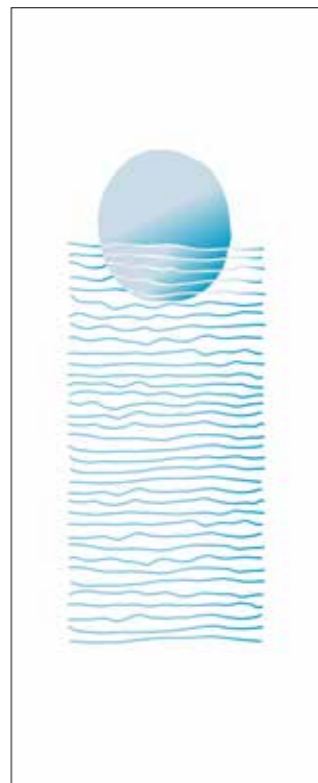

Alba

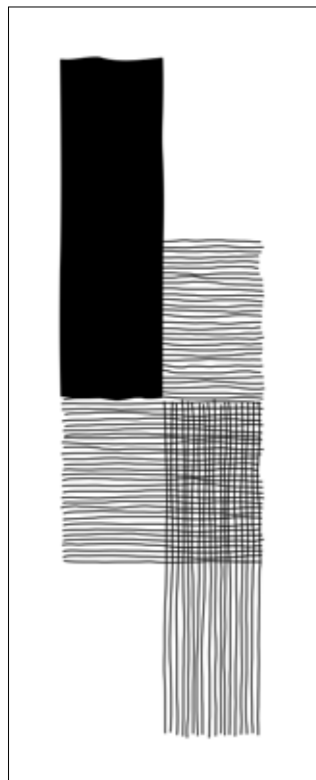

Graffiti nero

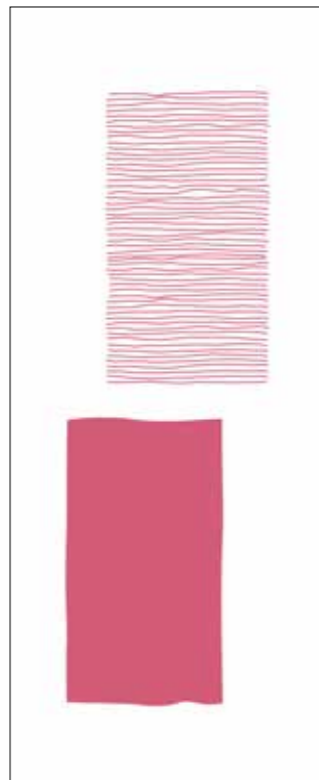

Graffiti fucsia

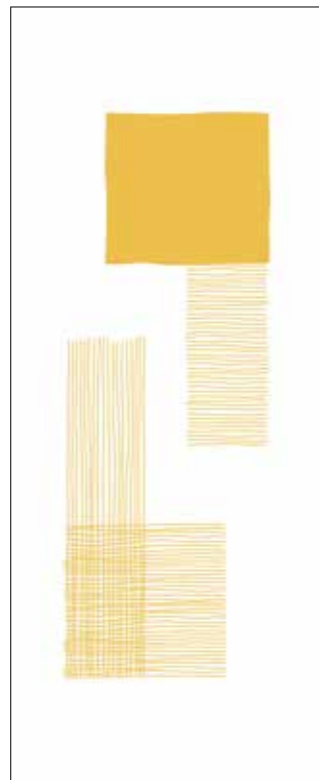

Graffiti giallo

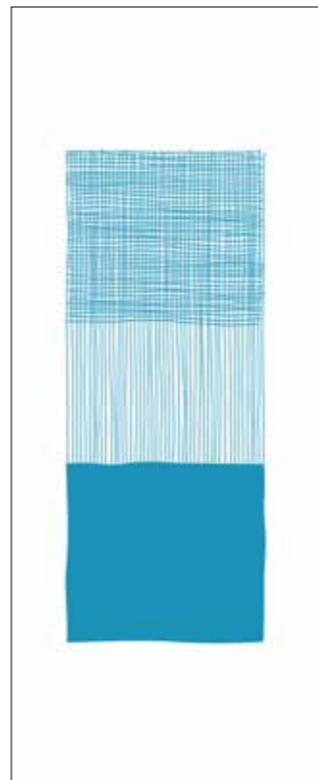

Graffiti celeste

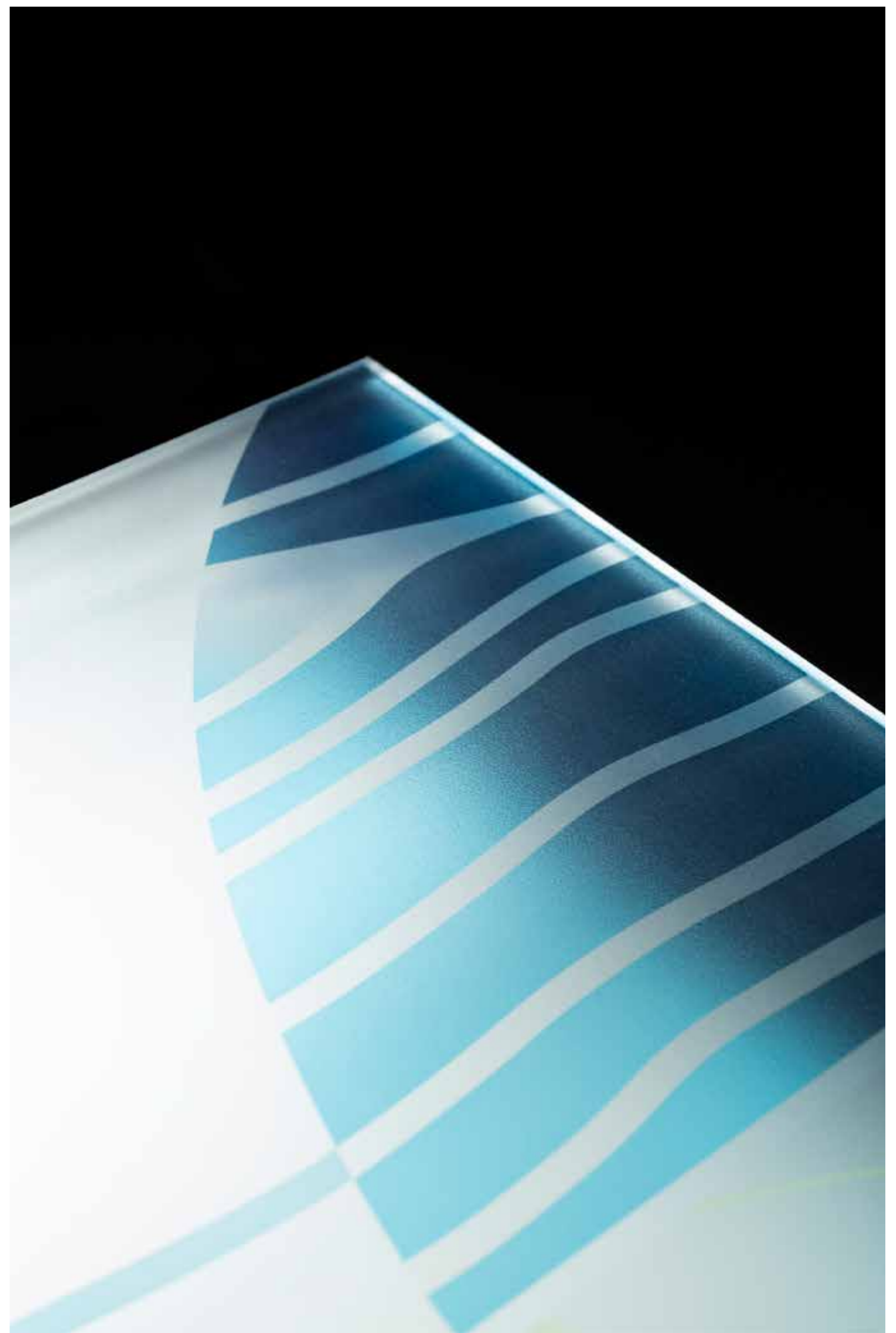

Vetri stampati classici



Ibiscus



Lotus



Flora

Per lavorazioni personalizzate, contattare l'ufficio commerciale.

For working on the request to contact the sales office.

Pour travailler sur la demande de contacter le bureau des ventes.

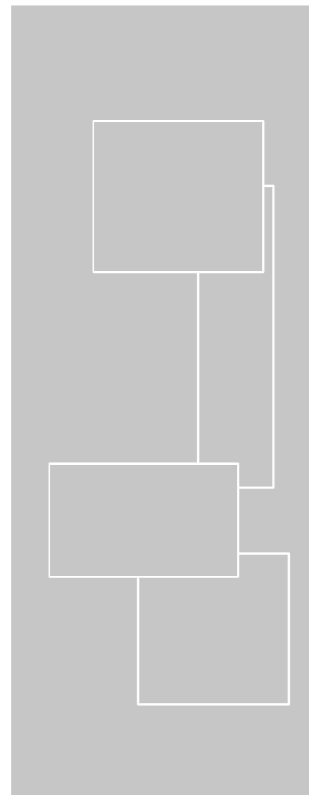

N01



N02

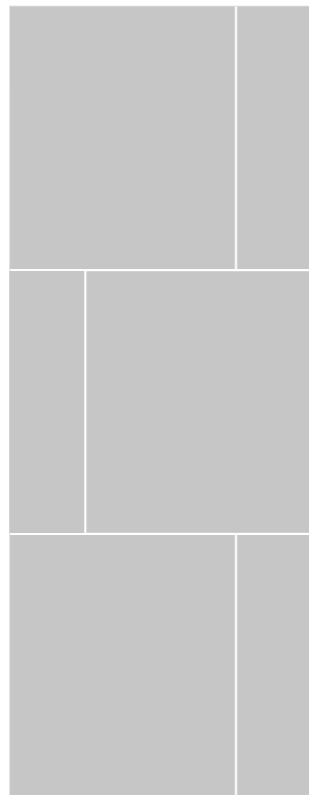

N04



N09

Vetri Textures

OTC DOORS dedica una costante ricerca e un'attenzione particolare alle tendenze stilistiche per rispondere alle esigenze funzionali del mondo dell'architettura.

I disegni della linea Textures sono realizzati con satinatura su uno o su entrambi i lati della lastra extrachiarata, in modo da garantire alta trasmissione luminosa e una superficie inalterabile con effetto anti-impronta e anti-graffio per la parte satinata. L'alternanza tra trasparente e satinato regala alla superficie un aspetto tridimensionale sempre nuovo e diverso con il variare della luce: prodotti emozionanti e versatili, adatti a ogni ambiente ed esigenza.

I vetri Textures sono forniti sempre in spessore 10 mm temperati.

OTC DOORS dedicates constant research and particular attention to style tendencies, in order to answer to the functional requirements of the world of architecture.

The designs of the Texture lines are created with a satin finish on one or both of the extra clear panes, in order to guarantee high light transmission and an unalterable surface, with anti-imprint and anti-scratch effects on the satin finished parts. Alternating between transparent and a satin finish gives the surface a three dimensional, ever new and different aspect with the varying of light; exciting and versatile products, adapted to all environments and requirements.

Textures glasses are always supplied in a thickness of 10 mm, tempered.

OTC DOORS a un souci constant pour la recherche et une attention particulière pour les tendances stylistiques pour répondre aux exigences fonctionnelles du monde de l'architecture.

Les dessins de la ligne Textures sont réalisés avec satinage sur un ou sur les deux côtés de la plaque extra-claire, de manière à garantir une transmission lumineuse élevée et une surface inaltérable avec effet anti-empreinte et anti-rayures pour la partie satinée. L'alternance entre transparent et satiné donne à la surface un aspect tridimensionnel toujours neuf et différent avec le changement de la lumière : des produits géniaux et polyvalents, adaptés à n'importe quel environnement et besoin.

Les verres Textures sont toujours fournis avec une épaisseur de 10 mm et trempés.

Vetri Textures
Textures glass
Verre Textures

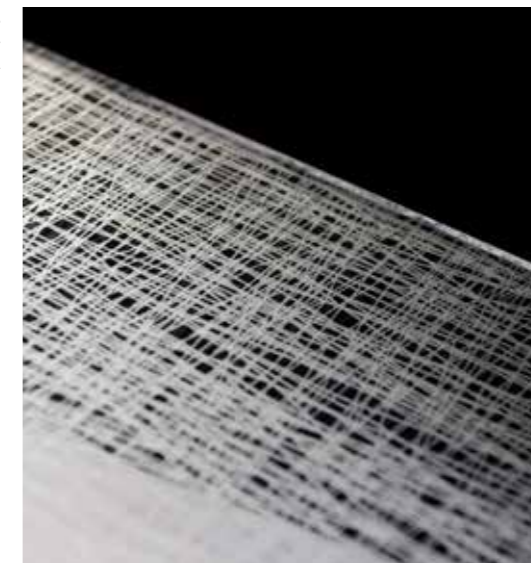

Nest

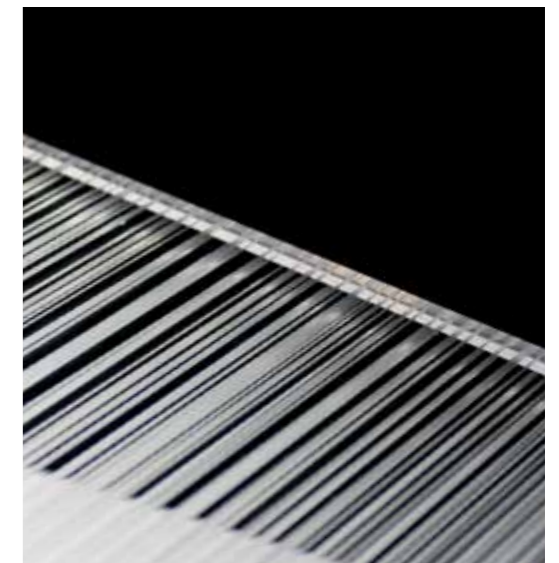

Bar Code

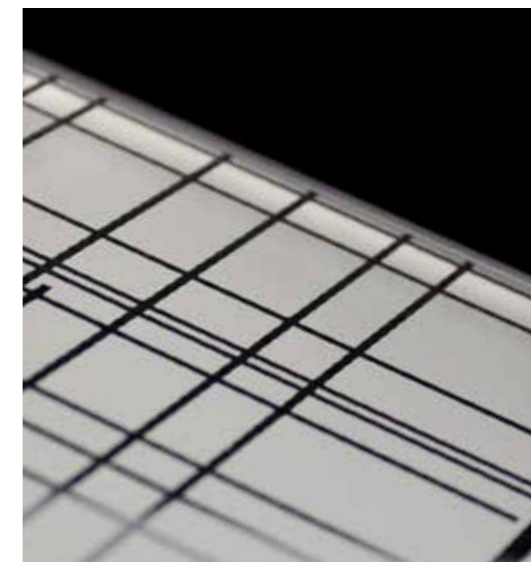

Mondrian



Denim

Sistemi di apertura tutto vetro

La porta tutto vetro è una soluzione di design che trasforma uno strumento funzionale di chiusura e separazione degli ambienti in un elemento estetico di arredamento che veste la casa con discrezione ed eleganza.

OTC DOORS offre 8 sistemi di apertura per ante scorrevoli e a battente a 1 o 2 ante, tutti dotati di guide ad alta prestazione da installazione esterno parete e a scomparsa.

All-glass opening system

The all-glass door is a design solution which transforms a functional closure instrument and separation of the environments, into an aesthetic furnishing element which dresses the home with discretion and elegance.

OTC DOORS offers 8 opening systems for 1 or 2 door sliding or hinged entrances, all equipped with high performance guides which can be installed outside the wall or hidden within it.

Systèmes d'ouverture entièrement en verre

La porte en verre est une solution design qui transforme un outil fonctionnel de fermeture et de séparation des pièces dans un élément esthétique d'ameublement qui habille la maison avec discrétion et élégance.

OTC DOORS propose 8 systèmes d'ouverture pour portes coulissantes et à battant avec 1 ou 2 vantaux, toutes équipées de guides à haute performance et dont l'installation se fait à l'extérieur du mur et escamotable.



Large

Sistema di scorrimento per porte a 1 o 2 ante con guida e mantovana classica in alluminio esterno parete, dotato di meccanismo di apertura e chiusura accompagnata "soft-stop".

Sliding system for 1 or 2 door openings with runners and classic pelmets in aluminium outside the wall, equipped with opening and closing mechanisms, combined with "soft stop".

Système de coulissement pour des portes avec 1 ou 2 vantaux, avec guide et lambrequin classique en aluminium à l'extérieur du mur, équipé d'un mécanisme d'ouverture et de fermeture accompagné « soft-stop ».

Anta doppia

Double door

Double porte

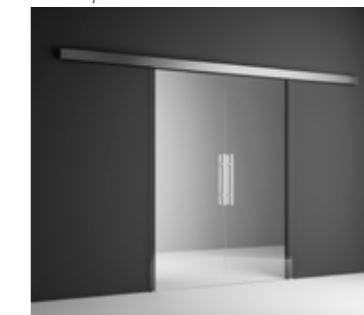

Small

Sistema di scorrimento esterno parete per porte a 1 o 2 ante con guida e mantovana minimale in alluminio, dotato di meccanismo di apertura e chiusura accompagnata "soft-stop".

Sliding system for 1 or 2 door openings outside the wall, with guides and minimal pelmets in aluminium, equipped with opening and closing mechanisms, combined with "soft stop".

Système de coulissement placé à l'extérieur du mur pour des portes avec 1 ou 2 vantaux, avec guide et lambrequin minimaliste en aluminium, équipé d'un mécanisme d'ouverture et de fermeture accompagné « soft-stop ».

Anta doppia

Double door

Double porte



Anta singola + fisso

Single door + fixed

Porte simple + fixe

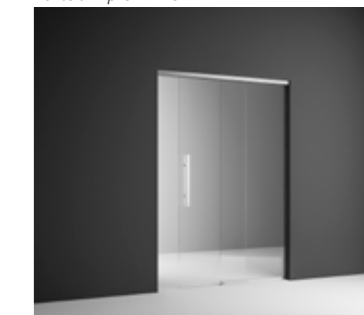

Minima

Sistema di scorrimento esterno parete con elementi di sostegno visibili su guida in alluminio per porte a 1 o 2 ante, dotato di meccanismo di apertura e chiusura accompagnata "soft-stop".

Sliding system outside the wall, with visible support elements on guides in aluminium for 1 or 2 door openings, equipped with opening and closing mechanisms, combined with "soft stop".

Système de coulissement avec des éléments de soutien visibles sur le guide en aluminium pour des portes avec 1 ou 2 vantaux, équipé d'un mécanisme d'ouverture et de fermeture accompagné « soft-stop ».

Anta doppia

Double door

Double porte





Invisibile Evo

Sistema di scorrimento esterno parete senza mantovana per porte a 1 o 2 ante, dotato di meccanismo di apertura e chiusura accompagnata "soft-stop".

Sliding system outside the wall for 1 or 2 door openings, equipped with opening and closing mechanisms, combined with "soft stop".

Système de coulissement placé à l'extérieur du mur sans lambrequin pour des portes avec 1 ou 2 vantaux, équipé d'un mécanisme d'ouverture et de fermeture accompagné « soft-stop ».

Anta doppia

Double door

Double porte

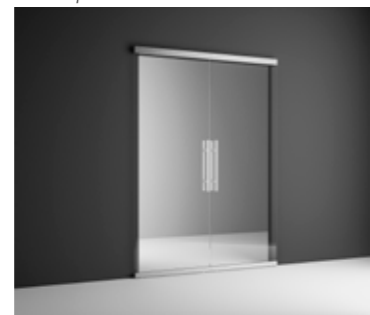

Ghost

Sistema di scorrimento esterno parete con mantovana nascosta nel controsoffitto per porte a 1 o 2 ante, dotato di meccanismo di apertura e chiusura accompagnata "soft-stop".

Sliding system outside the wall with pelmet hidden in the false ceiling for 1 or 2 door openings, equipped with opening and closing mechanisms, combined with "soft stop".

Système de coulissement placé à l'extérieur du mur avec lambrequin caché dans le faux plafond pour des portes avec 1 ou 2 vantaux, équipé d'un mécanisme d'ouverture et de fermeture accompagné « soft-stop ».

Anta doppia

Double door

Double porte

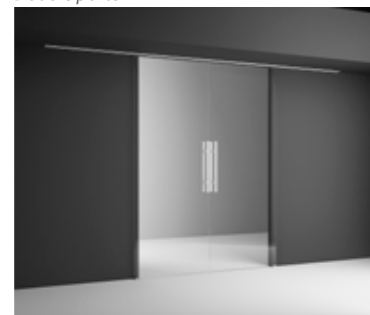

Anta singola + fisso

Single door + fixed

Porte simple + fixe

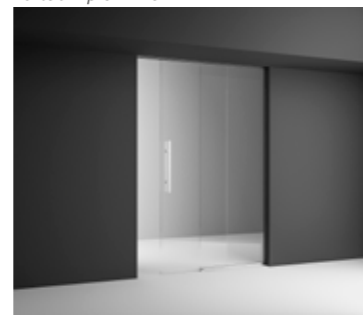

Madera

Sistema di scorrimento esterno parete con mantovana rivestita in legno o simil legno per porte a 1 o 2 ante, dotato di meccanismo di apertura e chiusura accompagnata "soft-stop".

Sliding system outside the wall with pelmet covered in wood or imitation wood, for 1 or 2 door openings, equipped with opening and closing mechanisms, combined with "soft stop".

Système de coulissement placé à l'extérieur du mur avec lambrequin en bois ou similibois pour des portes avec 1 ou 2 vantaux, équipé d'un mécanisme d'ouverture et de fermeture accompagné « soft-stop ».

Anta doppia

Double door

Double porte



Anta battente

Sistema ad anta battente con e senza serratura e cerniere metalliche montate su imbotte in legno.

L'ingombro di apertura è pari alla larghezza dell'anta.

The swing door system, with and without lock, with metal hinges mounted on wooden door jambs. The opening obstruction is the same as the width of the door.

Système avec vantail battant avec serrure et charnières métalliques montées sur des éléments rembourrés en bois. L'encombrement d'ouverture est égal à la largeur du vantail.



Anta va e vieni

Sistema ad un'anta va e vieni con cerniere metalliche montate su imbotte in legno, con apertura sia a spingere che a tirare.

L'ingombro di apertura è pari alla larghezza dell'anta.

System of swing doors with metal hinges mounted on wooden door jambs, which open out as well as in. The opening obstruction is the same as the width of the door.

Système avec vantail va-et-vient avec charnières métalliques montées sur des éléments rembourrés en bois, avec ouverture aussi bien à pousser qu'à tirer. L'encombrement d'ouverture est égal à la largeur du vantail.



Scorrevole a scomparsa

Sistema di scorrimento interno parete per porte a 1 o 2 ante.

Sliding system inside the wall for 1 or 2 door openings.

Système de coulissement mural intérieur pour des portes avec 1 ou 2 vantaux.

Anta doppia

Double door

Double porte



Accessori porte in vetro

Le porte tutto vetro OTC DOORS vanno oltre la decorazione della lastra: l'usabilità e la durata della porta dipendono dagli accessori di montaggio. OTC DOORS seleziona soltanto serrature e cerniere che garantiscano standard di resistenza elevati e finiture inossidabili.

Glass door accessories
 OTC DOORS All-glass doors go beyond the decoration of the panel; the usability and life of the door depends on the mounting accessories. OTC DOORS only selects fittings and hinges which guarantee a high standard of resistance to wear, and stainless steel finishes.

Accessoires des portes en verre
 Les portes entièrement en verre OTC DOORS vont au-delà de la décoration de la plaque : la facilité d'utilisation et la durée de la porte dépendent des accessoires de montage. OTC DOORS ne sélectionne que des serrures et des charnières qui garantissent des standards de résistance élevés et des finitions en acier inoxydable.

Sistemi di chiusura / Closure systems / Systèmes de fermeture

Aria V (LxH 193x53 mm)

Lato interno



Alluminio naturale

Lato esterno



Nero opaco

MV-720 PZ (LxH 156x76 mm)
 serratura con scrocco
 lock with latch
 serrure avec loquet

Nikel satinato



Cromo lucido



MV-720 WC (LxH 156x76 mm)
 serratura con scrocco
 lock with latch
 serrure avec loquet

Nikel satinato



Cromo lucido



M MV-720 PZ (LxH 156x76 mm)
 serratura magnetica
 magnetic lock
 serrure magnétique

Nikel satinato



Cromo lucido



M MV-720 WC (LxH 156x76 mm)
 serratura magnetica
 magnetic lock
 serrure magnétique

Nikel satinato



Cromo lucido



MV-404



Cromo lucido

Nikel satinato



MV-407



Cromo perla

Nikel satinato



MV-720 2FLG
 controserratura per due ante
 counterlocks for two doors
 counterlocks pour deux portes

Nikel satinato



M-SC
 scrocco per chiusura senza serratura
 latch for locking without lock
 loquet de verrouillage sans serrure

Cromo satinato



Cromo lucido



Cerniere / Hinges / Charnières

Aria CV (LxH 94x50 mm)

Alluminio naturale



Nero opaco



MV-809 (LxH 60x86 mm)

Nikel satinato



Cromo lucido



MV-509 SLIM (LxH 57x86 mm)

Cromo lucido



Nikel satinato



MV-709 (LxH 52x86 mm)

Cromo satinato



Cromo lucido



Cerniere per va e vieni / Hinges for swing doors / Charnières pour va-et-vient

MV-808 (LxH 73x109 mm)

Cromo lucido



Nikel satinato



Nicchie per scorrevoli / Niches for sliding doors / Niches pour portes coulissantes



Pomoli / Knobs / Boutons

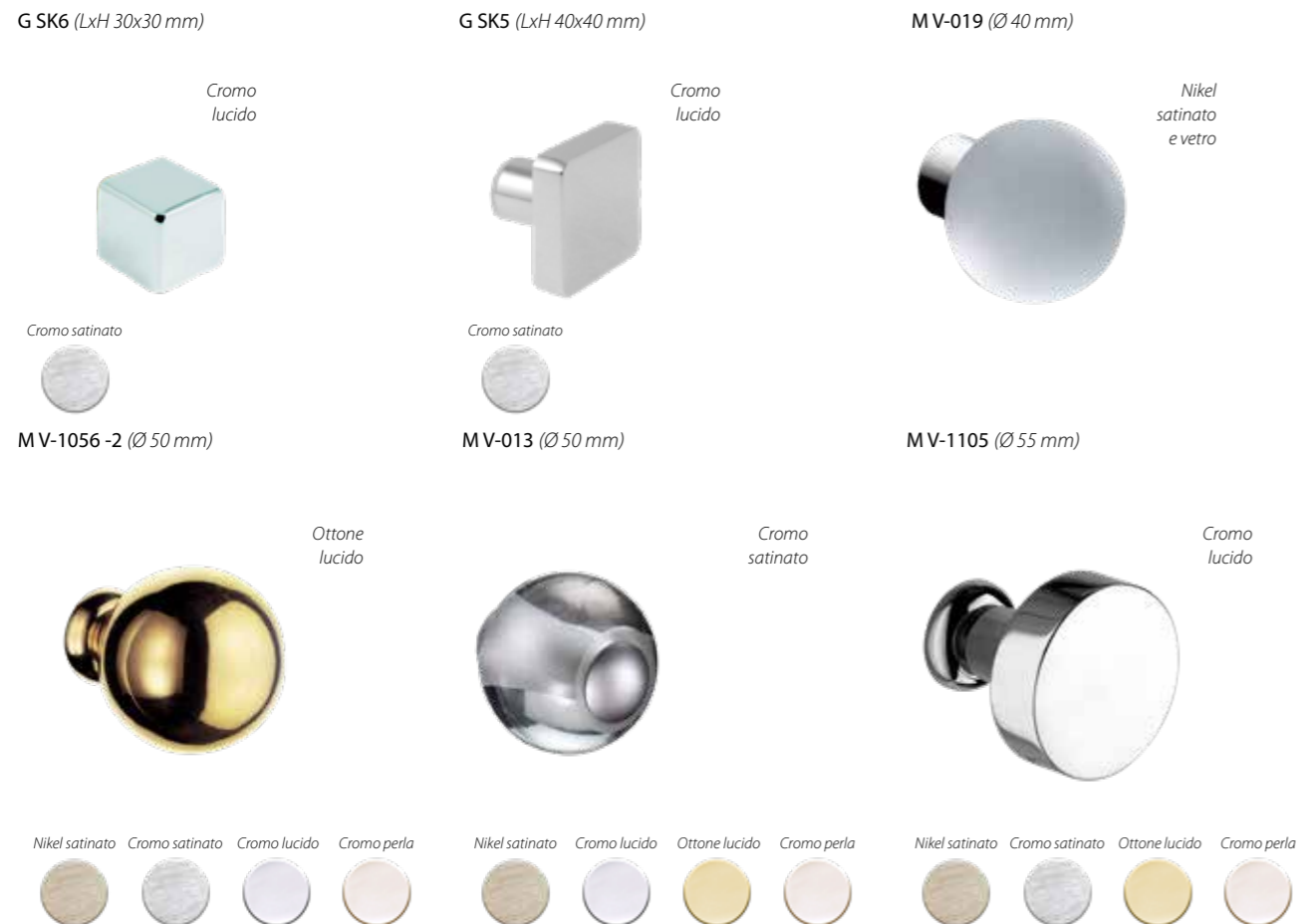

Maniglioni / Pull handles / Poignées tirantes



Campionario riepilogativo essenze e finiture

Utile strumento per una consultazione veloce delle essenze e delle finiture per tutte le linee di porte interne e porte blindate presentate in questo catalogo. Al momento dell'ordine Vi preghiamo di utilizzare i campioni reali disponibili presso il Vs rivenditore di fiducia. I colori e le finiture qui riportate sono puramente indicativi.

Useful instrument for a rapid consultation of the available woods for all the lines of internal and security doors presented in this catalogue. At the time of the order, we ask you to use the real samples available at your trusted sales outlet. The colours and finishes contained herein are purely indicative.

Instrument utile pour une consultation rapide des essences de bois disponibles pour toutes les lignes de portes internes et de portes blindées présentées dans ce catalogue. Au moment de la commande, nous vous prions d'utiliser les échantillons réels disponibles chez votre revendeur de confiance. Les couleurs et les finitions indiquées ici sont purement indicatives.

Laminati VENTIVENTI
Laminated VENTIVENTI
Laminé VENTIVENTI



Latte



Gesso



Piuma



Sandalo



Calce



Corda

Verificare su mazzetta i colori reali, quelli riportati sul presente catalogo sono puramente indicativi.
Check wad of real colors, as shown in this catalog are purely indicative.
Vérifiez sur échantillon les couleurs réelles, comme indiqué dans ce catalogue sont purement indicatives.

Essenze
Essences
Essences



Tanganica Tinto Medio
Tanganika Dyed Medium
Tanganika Teinté Moyenne



Tanganica Tinto Ciliegio
Tanganika Dyed Cherry
Tanganika Teinté Cerise



Rovere Naturale
Natural Oak
Chêne Naturel



Rovere Tabacco
Oak Tobacco
Chêne Tabac

Essenze
Essences
Essences



Rovere Tinto Miele
Oak Dyed Honey
Chêne Teinté Miel



Castagno Tinto Medio
Chestnut Dyed Medium
Châtaigne Teinté Moyenne



Noce Nazionale Tinto Medio
Italian Walnut Dyed Medium
Noyer Italien Teinté Moyenne



Castagno Laccato a Poro Aperto RAL 9003
Open Pore Lacquered RAL 9003
Châtaigne Laqué Pore ouvert RAL 9003

Verificare su mazzetta i colori reali, quelli riportati sul presente catalogo sono puramente indicativi.
Check wad of real colors, as shown in this catalog are purely indicative.
Vérifiez sur les échantillons les couleurs réelles, comme indiqué dans ce catalogue sont purement indicatives.

Laccato colori standard
Lacquered standard colors
Couleurs standard laqués

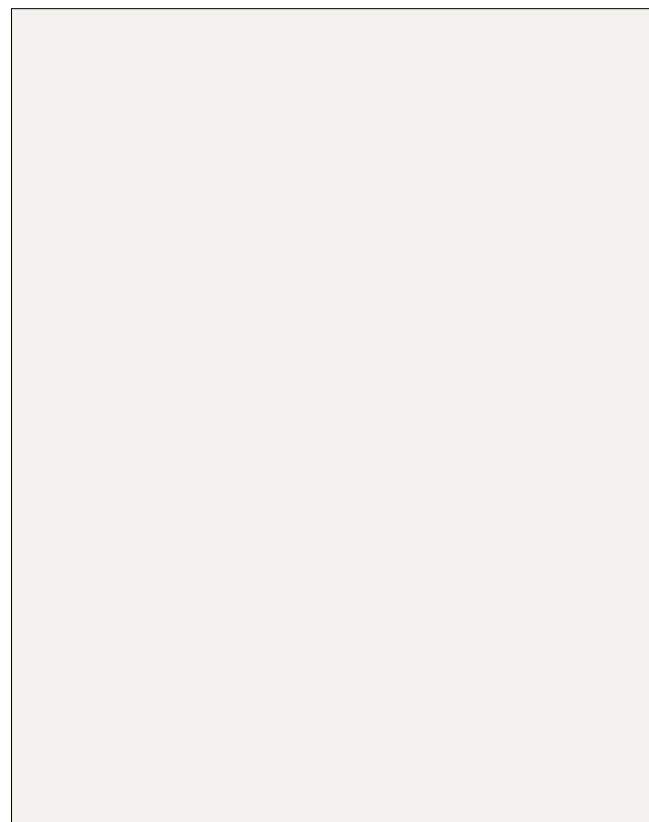

RAL 9003

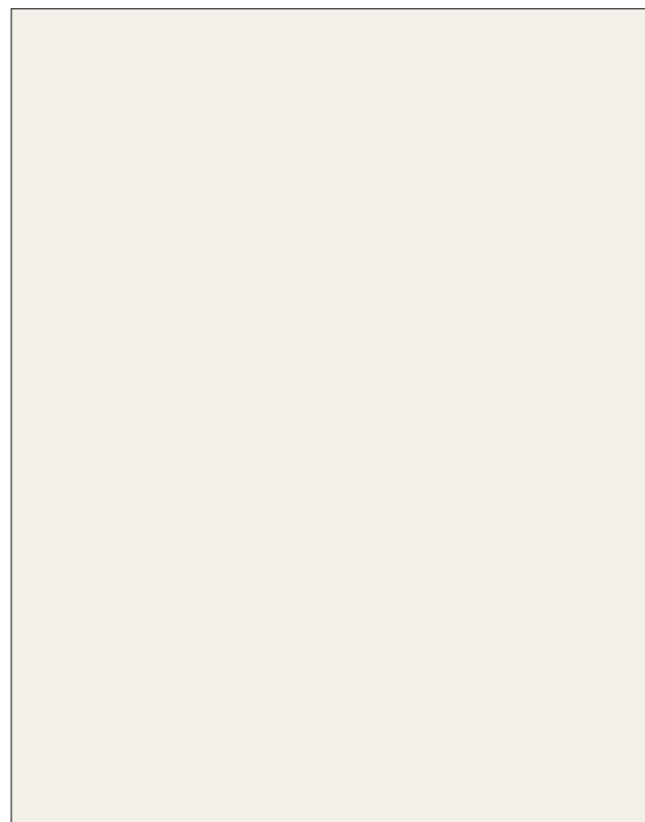

RAL 9010

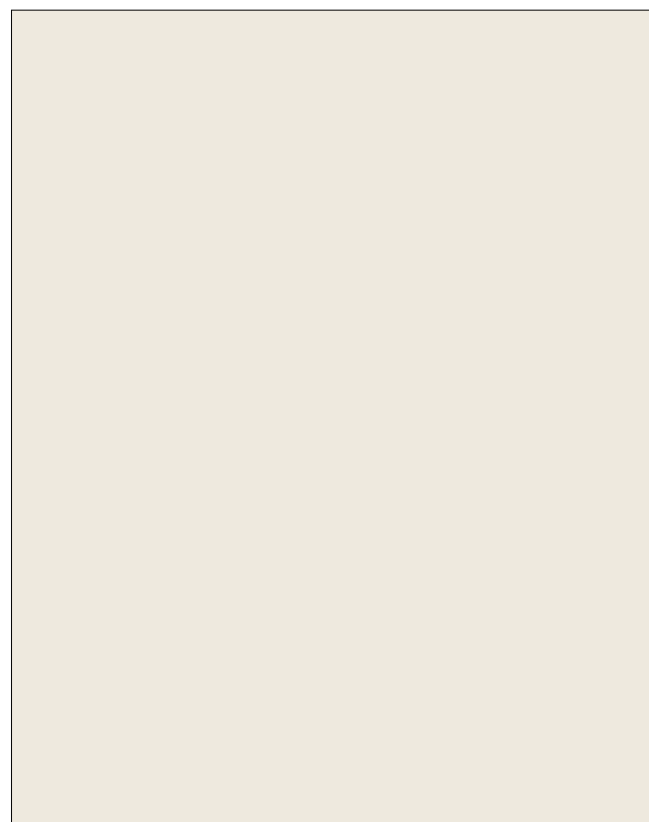

RAL 9001

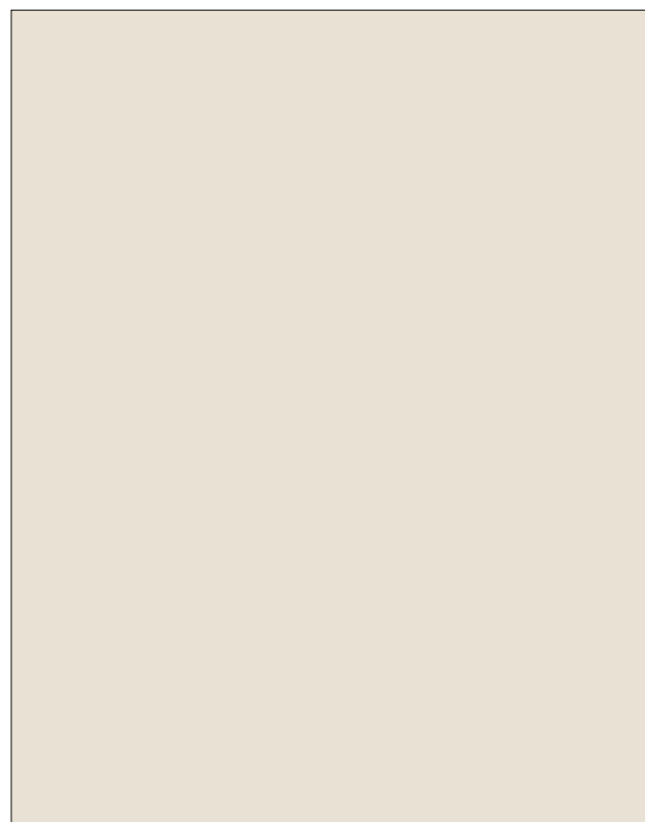

RAL 1013

Laccato RAL (opzionale)
Lacquered RAL (optional)
Couleurs RAL (sur demande)

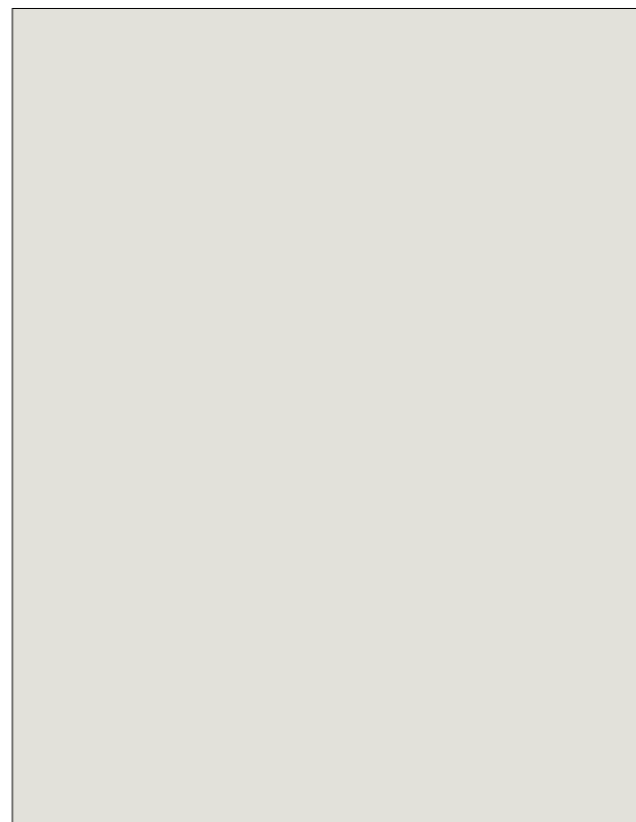

RAL 9002

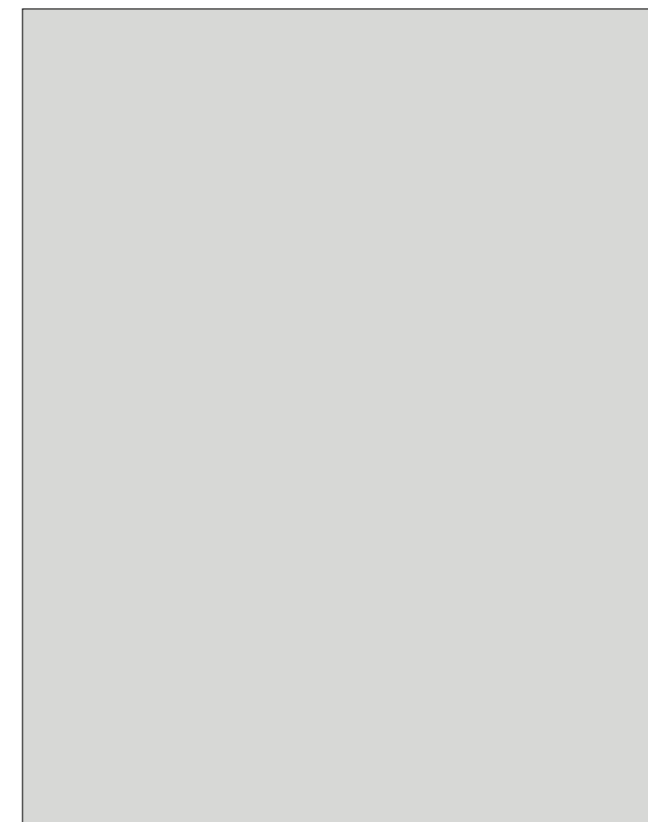

RAL 9018

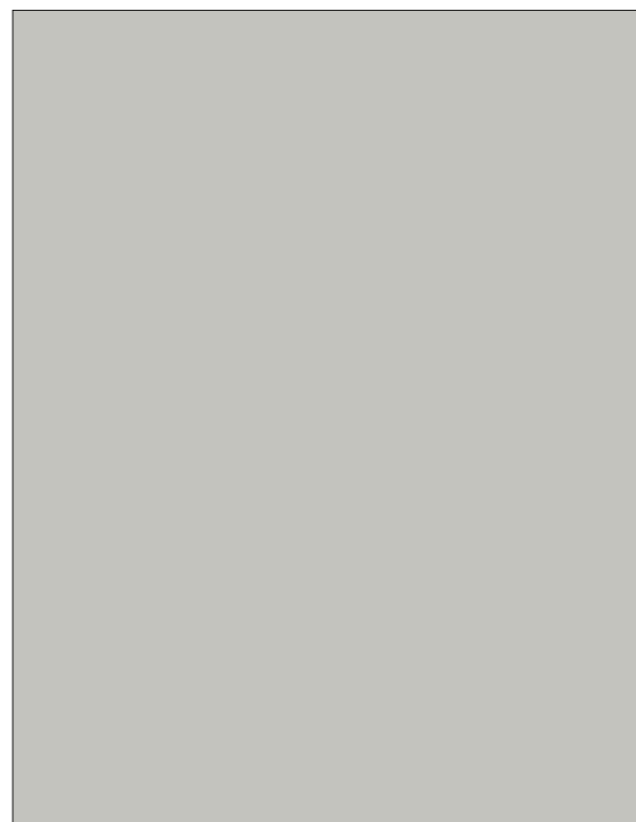

RAL 7038



RAL 7024

Verificare su mazzetta i colori reali, quelli riportati sul presente catalogo sono puramente indicativi.
Check wad of real colors, as shown in this catalog are purely indicative.
Vérifiez sur les échantillons les couleurs réelles, comme indiqué dans ce catalogue sont purement indicatives.

Laccato RAL (opzionale)
Lacquered RAL (optional)
Couleurs RAL (sur demande)

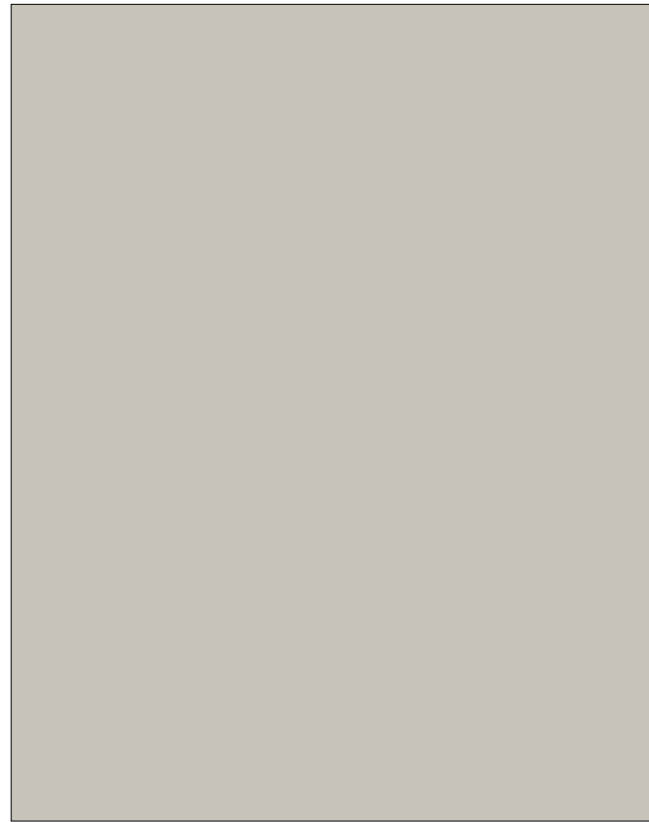

RAL 7032

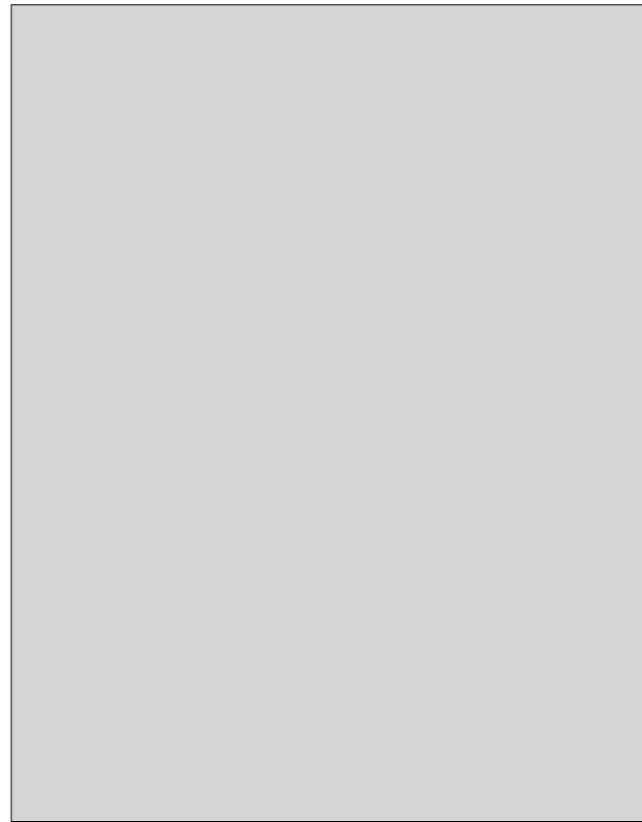

RAL 7035

Laccato RAL (opzionale)
Lacquered RAL (optional)
Couleurs RAL (sur demande)

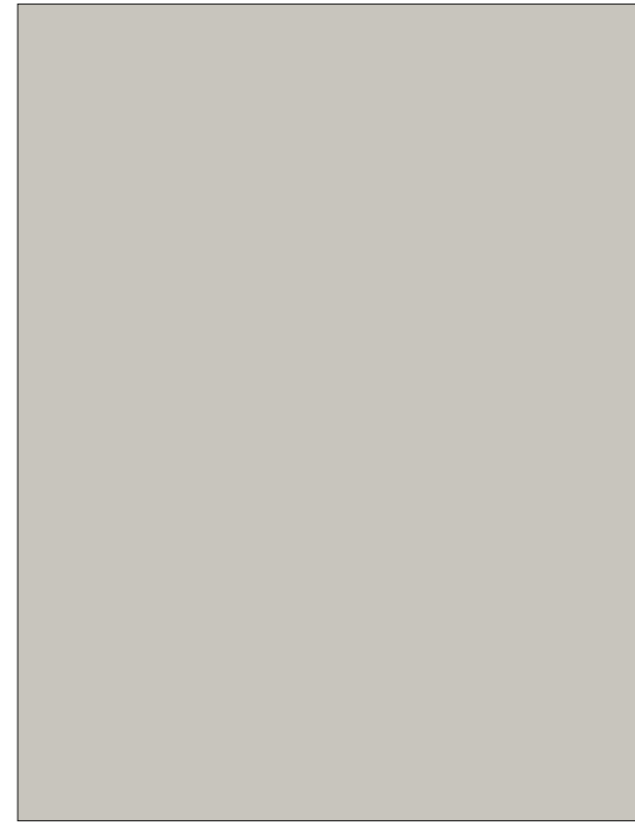

RAL 7044

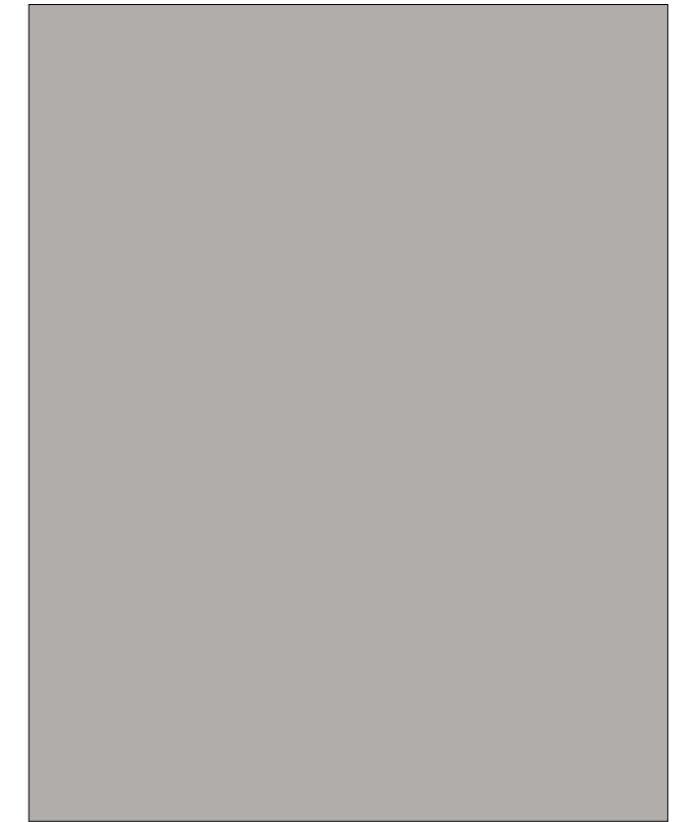

RAL 7036

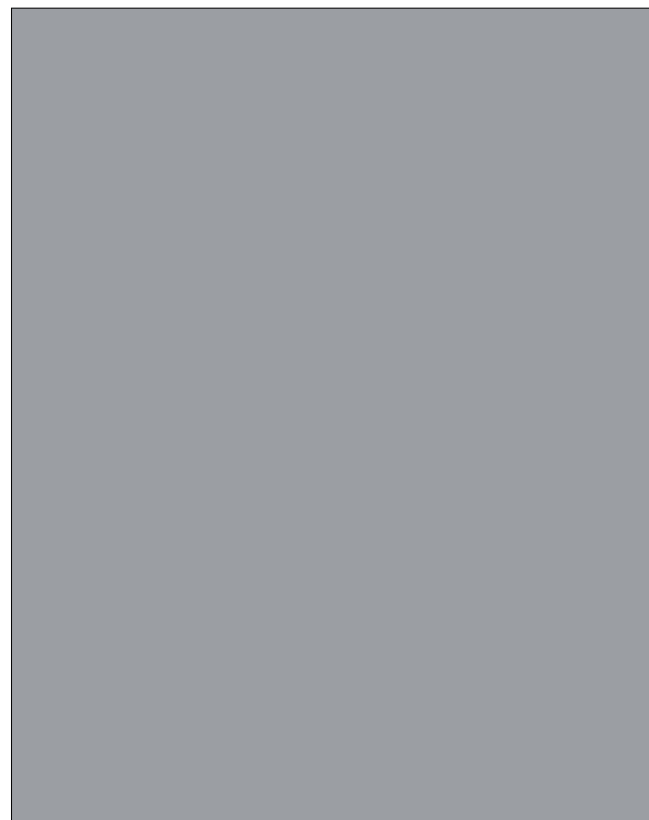

RAL 7046

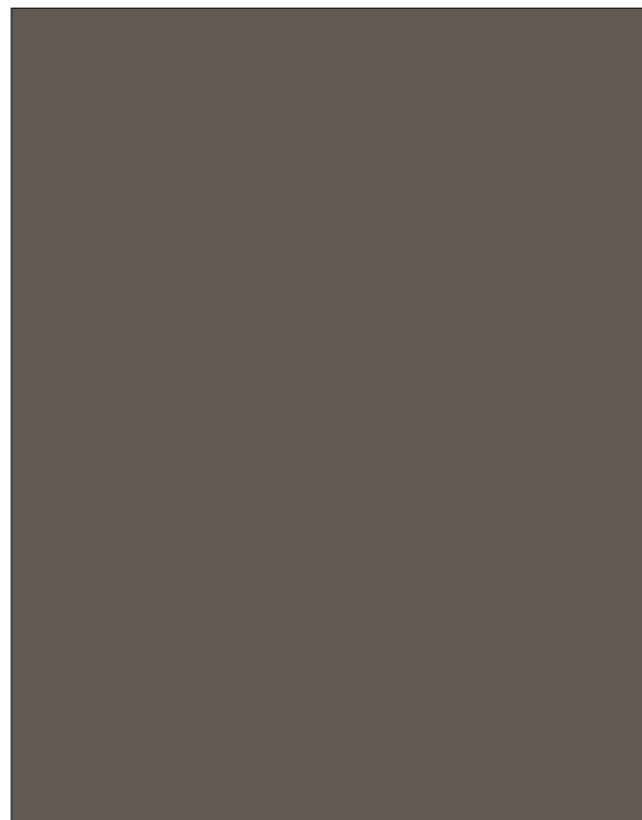

RAL 8019

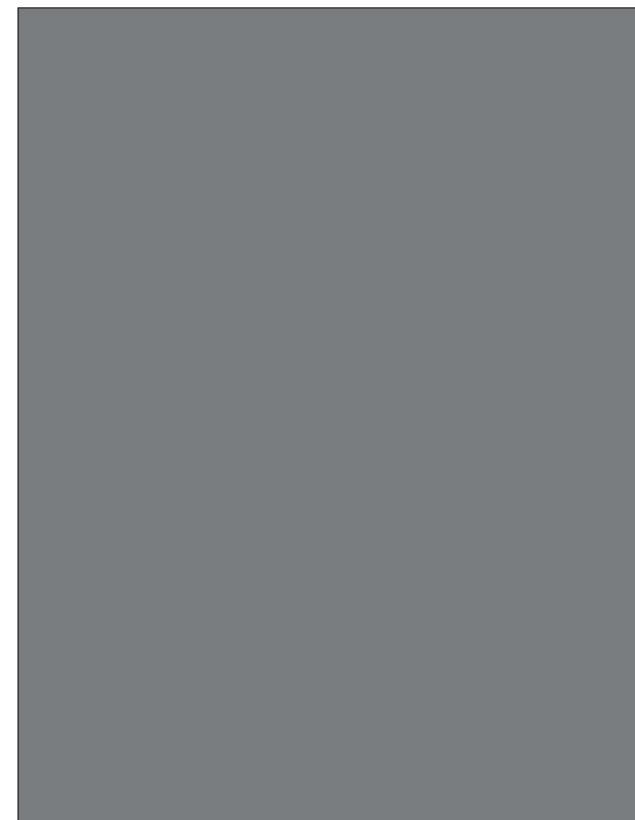

RAL 7012

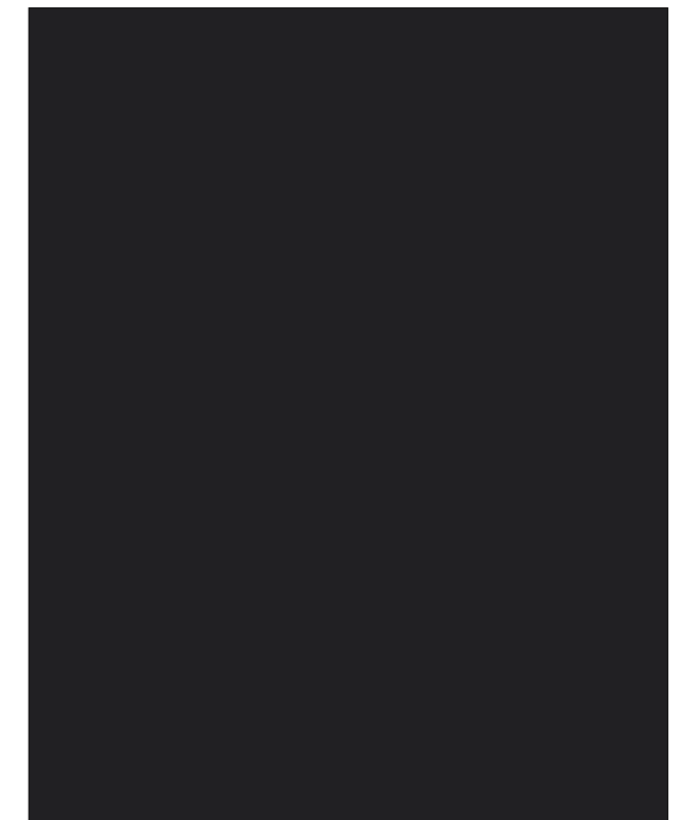

RAL 9011

Laccati
Lacquered
Laqué



RAL

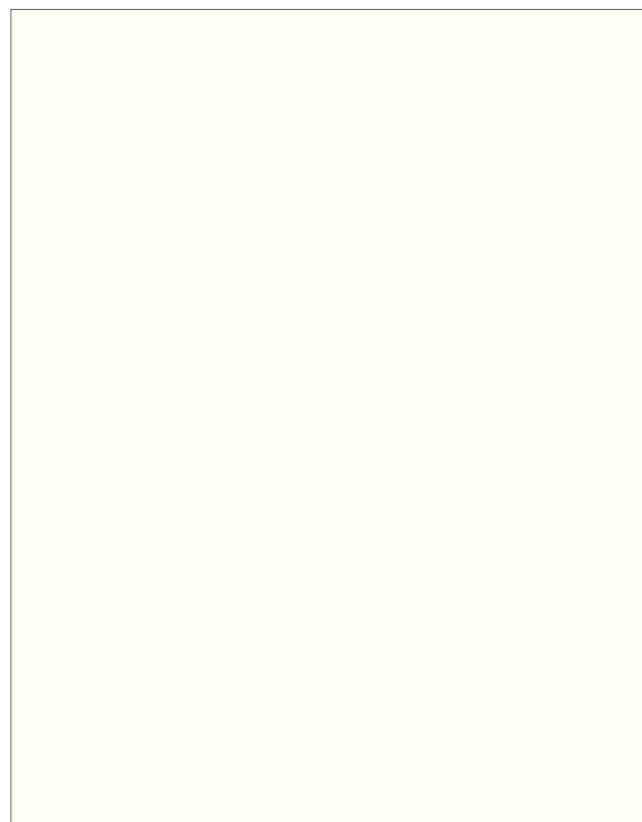

Finitura opaca (di serie)
Matte finish (standard)
Finition mate (standard)



Finitura lucida (opzionale)
Glossy finish (optional)
Finition brillante (sur demande)

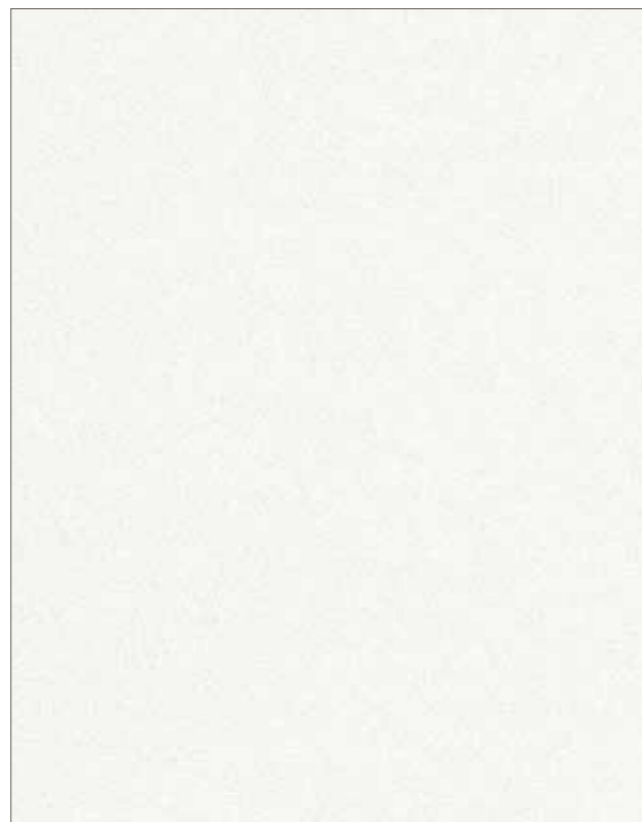

Finitura goffrato fine (opzionale)
Finish embossed (optional)
Terminer en relief (sur demande)

Verificare su mazzetta i colori reali, quelli riportati sul presente catalogo sono puramente indicativi.
Check wad of real colors, as shown in this catalog are purely indicative.
Vérifier les couleurs réelles, comme indiqué dans ce catalogue sont purement indicatives.



Laccati Decò
Lacquered Decò
Laqué Decò

Decò - Finiture eseguite a mano
 Decò - Hand-made finishes
 Decò - Finitions à la main

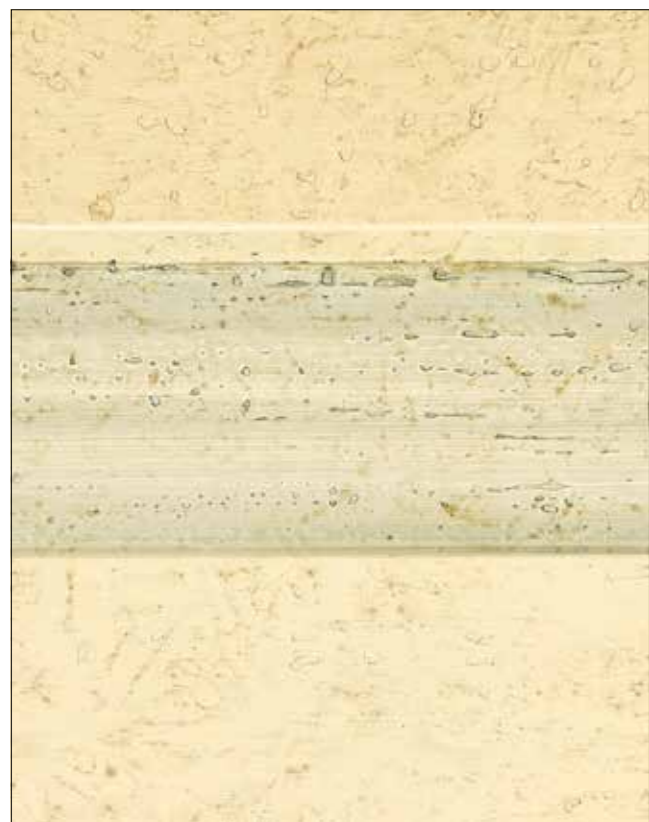

p1



p2



p5



p6

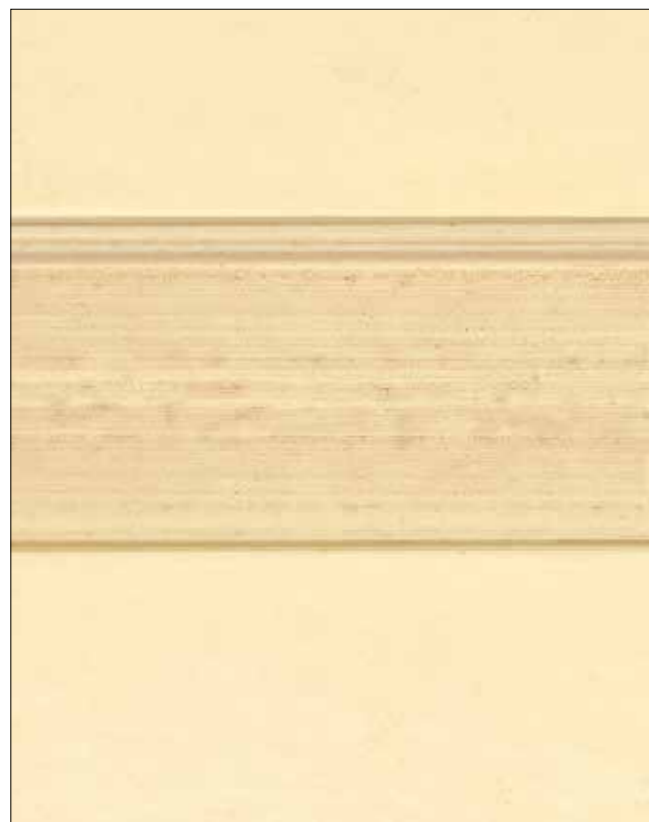

p3



p4



Castagno Decò L1
 Decò L1 Chestnut
 Châtaigne Decò L1



Castagno Decò L2
 Decò L2 Chestnut
 Châtaigne Decò L2

Verificare su mazzetta i colori reali, quelli riportati sul presente catalogo sono puramente indicativi.
 Check wad of real colors, as shown in this catalog are purely indicative.
 Vérifier les couleurs réelles, comme indiqué dans ce catalogue sont purement indicatives.



Design for contract

Hotellerie, Office, Medical, Public, Residential.
Dal dialogo tra finiture, materiali e prestazioni nascono soluzioni tecnologiche e personalizzate che rispondono con affidabilità ed efficienza alle esigenze del settore contract internazionale. L'esperienza maturata in oltre 40 anni, unitamente alla professionalità dei propri addetti, consentono ad OTCDOORS di realizzare qualsiasi progetto.

Hotellerie, Office, Medical, Public, Residential.
Dal dialogo tra finiture, materiali e prestazioni nascono soluzioni tecnologiche e personalizzate che rispondono con affidabilità ed efficienza alle esigenze del settore contract internazionale. L'esperienza maturata in oltre 40 anni, unitamente alla professionalità dei propri addetti, consentono ad OTCDOORS di realizzare qualsiasi progetto.

Hotellerie, Office, Medical, Public, Residential.
Dal dialogo tra finiture, materiali e prestazioni nascono soluzioni tecnologiche e personalizzate che rispondono con affidabilità ed efficienza alle esigenze del settore contract internazionale. L'esperienza maturata in oltre 40 anni, unitamente alla professionalità dei propri addetti, consentono ad OTCDOORS di realizzare qualsiasi progetto.





103

private

Tutte le illustrazioni del catalogo, e le descrizioni dei prodotti, sono puramente indicative. ITP DOORS srl declina ogni eventuale variazione cromatica che venga riscontrata sul prodotto e che non corrisponda alle immagini presenti a catalogo, ricordando che i colori per loro stessa natura potrebbero risultare differenti da quelli illustrati. ITP DOORS srl si riserva il diritto di apportare modifiche ai prodotti, in qualsiasi momento e senza preavviso, al fine di migliorare la produttività e la funzionalità del prodotto. La riproduzione anche parziale delle immagini è vietata a norma di legge. Le tecniche di stampa e di fotografia non consentono una perfetta e fedele riproduzione dei colori, devono quindi essere considerati puramente indicativi e a livello pubblicitario. ITP DOORS srl non accetterà pertanto, alcun reclamo per eventuali differenze tra merce fornita e materiale pubblicitario.

All illustrations in the catalog, and product descriptions are purely of an indicative nature. ITP DOORS srl disclaims responsibility for any variation in product colors that does not correspond to the images shown in the catalog, and points out that colors by their very nature may be different from those shown. We reserve the right to make changes at any time and without notice in order to improve product features and productivity. The reproduction of images, even partially, is prohibited by law. Printing and photographic techniques do not allow perfect and faithful color reproduction, and should, therefore, be considered merely as guidelines and as advertising. ITP DOORS srl will not accept, therefore, any claim for any discrepancies arising between goods supplied and advertising material.

Toutes les illustrations dans le catalogue ainsi que les descriptions des produits ne sont fournies qu'à titre purement indicatif. ITP DOORS srl décline toute variante éventuelle dans la couleur d'un produit ne correspondant pas exactement aux illustrations du catalogue, tout en soulignant que les couleurs par leur nature même, peuvent être différentes de celles des illustrations. Nous nous réservons le droit d'apporter des modifications sur nos produits à tout moment et sans préavis, afin d'améliorer leur productivité et caractéristiques. La reproduction, même partielle, des images est interdite par la loi. Les techniques d'impression et de photographie ne peuvent rendre une reproduction parfaite et fidèle des couleurs, et doivent donc être considérées comme étant à titre purement indicatif et d'un niveau publicitaire. Par conséquent ITP DOORS srl ne sera pas en mesure d'accepter des réclamations concernant d'éventuelles différences entre les marchandises livrées et le matériel publicitaire.